

CATALOGUE PRODUITS



VIF
FURNITURE

www.vif-furniture.com
03.20.20.78.80

Distributeur CHR
indépendant

L'ÉQUIPE VIF FURNITURE

Nos bureaux et notre
dépôt logistique sont
situés en Moselle

DIRECTEUR

Jérémy Tarrats

SERVICE ACHAT

Vinoliya Sent Doux

SERVICE COMMERCIAL

Secteur Est

Julie Redonnet
julie@vif-furniture.com

Secteur Ouest

Nathalie Wawrzyniak
nathaliew@vif-furniture.com

Secteur Paris / DOM-TOM / Export

Jérémy Tarrats
jeremy@vif-furniture.com

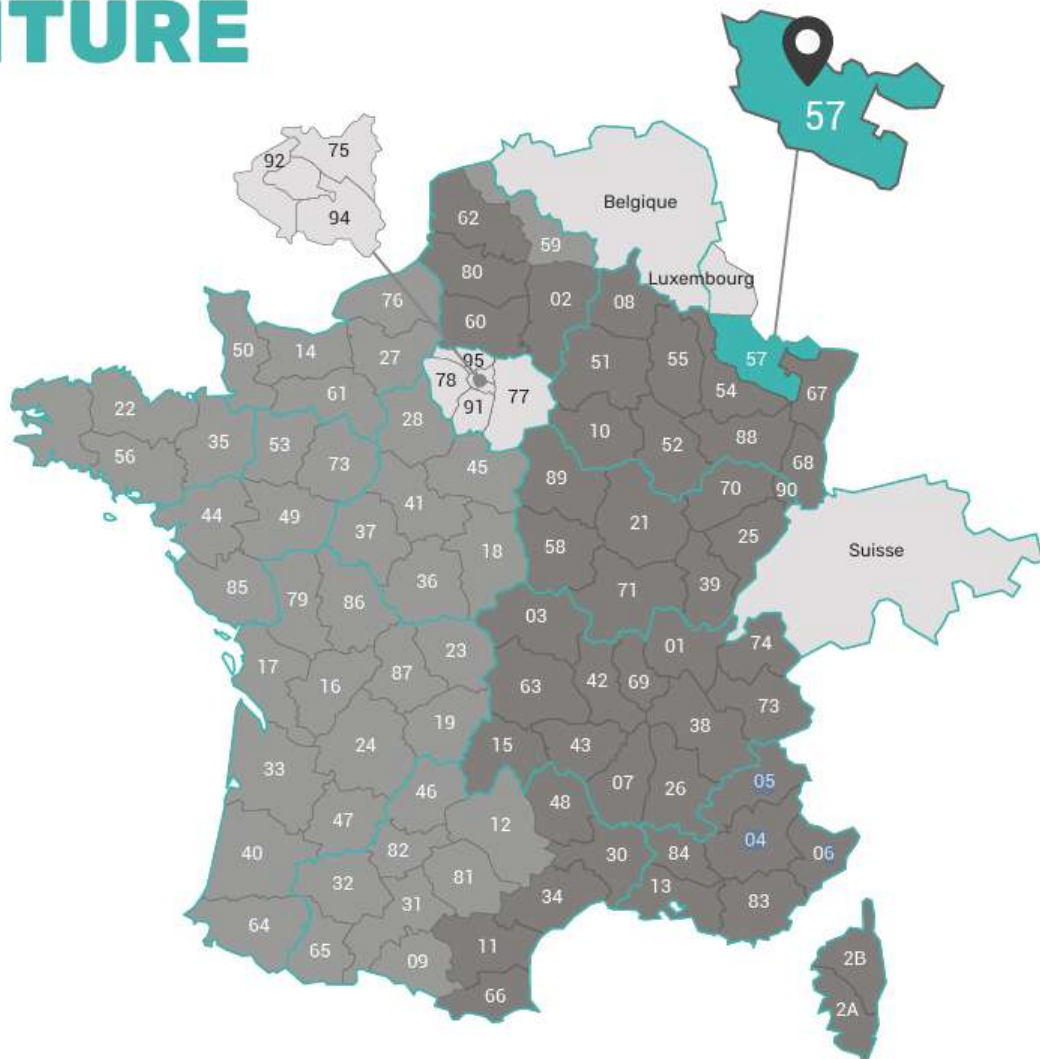

VIF FURNITURE

www.vif-furniture.com

03.20.20.78.80

































TREMERY (METZ)





















Distributeur CHR
indépendant



Légende

Legend

	Largeur Totale <i>Total width</i>		Longueur x largeur du plateau <i>Table top length x width</i>
	Profondeur Totale <i>Total depth</i>		Longueur x largeur de la base <i>Base length x width</i>
	Hauteur totale <i>Total height</i>		Hauteur de la table <i>Table height</i>
	Hauteur assise <i>Seat height</i>		Diamètre du plateau <i>Table top diameter</i>
	Hauteur d'accoudoir (centre) <i>Armrest height (centre)</i>		Diamètre de la base <i>Table base diameter</i>
	Poids Net <i>Net weight</i>		Hauteur de la table <i>Table height</i>
	Diamètre de l'assise <i>Seat diameter</i>		Dimensions de la table pliée <i>Folded table measurements</i>
	Diamètre de la base <i>Base diameter</i>		Longueur de la croix <i>Cross length</i>
	Hauteur du tabouret <i>(Bar)Stool height</i>		Longueur x largeur de la base <i>Base length x width</i>
	Longueur x largeur du plateau <i>Table top length x width</i>		Diamètre de la base <i>Table base diameter</i>
	Hauteur de la table <i>Table height</i>		Longueur de la base <i>Base length</i>
	Longueur x largeur du plateau <i>Table top length x width</i>		Hauteur du piétement <i>Table base height</i>
	Longueur x largeur de la base <i>Base length x width</i>		Hauteur du piétement <i>Table base height</i>
	Hauteur de la table <i>Table height</i>		Hauteur du piétement <i>Table base height</i>
	Charge maximale sur la table <i>Maximum table load</i>		Dimensions plateau min. ou max. conseillées <i>Min. or max. advised table top sizes</i>
	Diamètre de la table <i>Table diameter</i>		Diamètre du tube <i>Tube diameter</i>
	Hauteur de la table <i>Table height</i>		

	Empilable <i>Stackable</i>		Classement non-feu (+N° Norme) <i>Fire resistant rating (+N° Norm)</i>
	Pliable & encastrable <i>Foldable & stackable</i>		Hydrofuge <i>Water repellent</i>
	Table pliante <i>Folding table</i>		Nettoyage facile <i>Easy clean</i>
	Conditionnement <i>Packaging</i>		Lavage Facile <i>Easy care</i>
	Usage extérieur <i>Outdoor use</i>		Polyester recyclé <i>Recycled polyester</i>
	Usage intérieur uniquement <i>Indoor use only</i>		Utilisation Bord de mer <i>Seaside use</i>
	À monter <i>To be assembled</i>		Mat - Faible réflectivité <i>Low light reflectivity</i>
	Numéro de l'échantillon <i>Sample reference number</i>		Anti-traces de doigts <i>Fingerprint-proof</i>
	Résistance aux UV <i>UV resistant</i>		«Gestion responsable des forêts» <i>Forest Stewardship Council</i>
	Test de longévité sur le système pliant : 2000 cycles <i>Folding mechanism durability test : 2000 cycles</i>		Produit certifié - Faibles émissions de substances chimiques - UL 2818 <i>Product certified for low chemical emissions - UL 2818</i>



Infos Techniques - *Technical Information*

Retrouvez l'ensemble des informations techniques en fin de catalogue.
Find all the technical information at the end of the catalog





Extérieur Outdoor

- 10-121 Assises
Seats
- 122-125 Tables
Tables
- 126-139 Piètements
Table Bases
- 140-145 Plateaux
Table Tops

Intérieur Indoor

- 148-259 Assises
Seats
- 260-265 Tables Basses
Low tables
- 266-277 Piètements
Table Bases
- 278-287 Plateaux
Table Tops
- 288-291 Meubles
Furniture

Réception Catering

- 294-295 Assises
Seats
- 296-299 Tables
Tables

Divers Miscellaneous Infos

- 302-311 Informations techniques
Technical information
- 312-315 Correspondance Pieds/Plateaux
Matching table tops and bases
- 316 Pièces détachées
Spare parts
- 318-325 Index
Index





Extérieur - Outdoor

Loom

New

Chaise - Chair



Rotin Naturel
Natural Rattan

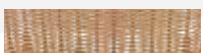





 p303



S13
R34

Structure métallique - Peinture époxy : Noir - Epaisseur tube 2mm - Diamètre tube 16mm - Tressage PE imitation rotin.
Metal frame - Powder coating : Black - Tube thickness 2mm - Tube diameter 16mm - PE wicker rattan look.

    
51 53 81 48 5,3





Loom

Loyd

New

Tabouret - *Barstool*



Rotin Naturel
Natural Rattan

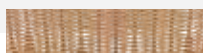

 p303



S13
R34

Structure métallique - Peinture époxy : Noir - Epaisseur tube 2mm - Diamètre tube 16mm - Tressage PE imitation rotin.
Metal frame - Powder coating : Black - Tube thickness 2mm - Tube diameter 16mm - PE wicker rattan look.



53 54 104 77 5,9





Loyd

Metz

New

Fauteuil - Armchair









Rotin Noisette
Nut Rattan



 p302-303  S4
R16

Structure en aluminium - Peinture époxy : Bamboo look caramel - Épaisseur tube 1,5mm - Diamètre tube 28mm - Tressage PE imitation rotin.

Aluminum frame - Powder coating : Caramel Bamboo look - Tube thickness 1,5mm - Tube diameter 28mm - PE wicker rattan look.

     
56 60 79 44 69 3,8

  4max



Metz

Dax

Chaise - Chair

New



STRUCTURE
FRAME

Bamboo Look Foncé
Dark Bamboo Look

New



Bamboo Look Caramel
Caramel Bamboo Look



TRESSAGE
WICKER

Rotin Marron Foncé
Dark Brown Rattan

New

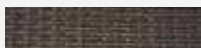

Rotin Noisette
Nut Rattan



ⓘ p302-303



S4,S27
R16,R27

Structure en aluminium - Peinture époxy : Bamboo look - Épaisseur tube 1,8mm - Diamètre tube 25mm - Tressage PE imitation rotin.

Aluminum frame - Powder coating : Bamboo look - Tube thickness 1,8mm - Tube diameter 25mm - PE wicker rattan look.

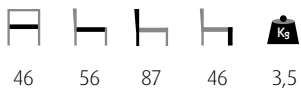



Dax

Orléans

Chaise - Chair







Rotin Noisette
Nut Rattan



 p302-303  S4
R16

Structure en aluminium - Peinture époxy : Bamboo look caramel - Épaisseur tube 1,5mm - Diamètre tube 28mm - Tressage PE imitation rotin.

Aluminum frame - Powder coating : Caramel Bamboo look - Tube thickness 1,5mm - Tube diameter 28mm - PE wicker rattan look.

    
54 56 82 45 3,5





Orléans

Rochelle

Fauteuil - Armchair



Rotin Noisette
Nut Rattan



 p302-303  S4
R16

Structure en aluminium - Peinture époxy : Bamboo look caramel - Épaisseur tube 1,5mm - Diamètre tube 28mm - Tressage PE imitation rotin.

Aluminum frame - Powder coating : Caramel Bamboo look - Tube thickness 1,5mm - Tube diameter 28mm - PE wicker rattan look.





Rochelle

Brest

Tabouret - Barstool



Rotin Noisette
Nut Rattan



 p302-303  S4
R16

Structure en aluminium - Peinture époxy : Bamboo look caramel - Épaisseur tube 1,5mm - Diamètre tube 28mm - Tressage PE imitation rotin.

Aluminum frame - Powder coating : Caramel Bamboo look - Tube thickness 1,5mm - Tube diameter 28mm - PE wicker rattan look.



36 49 45 2





Brest

Laval

Tabouret - *Barstool*



Rotin Noisette
Nut Rattan



 p302-303



S4
R16

Structure en aluminium - Peinture époxy : Bamboo look caramel - Épaisseur tube 1,5mm - Diamètre tube 28mm - Tressage PE imitation rotin.

Aluminum frame - Powder coating : Caramel Bamboo look - Tube thickness 1,5mm - Tube diameter 28mm - PE wicker rattan look.

   
36 47 76 2,7





Laval

Murcia

Fauteuil - Armchair



Taupe
Taupe

Noir
Black

Terracotta
Terracotta

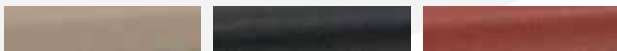

p302



S23,S24,S25
R20,R21,R22,
R23,R24,R25

Structure en aluminium - Peinture époxy - Épaisseur tube 1,35mm renforcé par tube intérieur de 1mm - Diamètre tube 25mm - Tressage corde textilène - Coussin polyester 4cm inclus, fixé par velcro.

Aluminum frame - Powder coating - Tube thickness 1,35mm reinforced by 1mm inner tube - Tube diameter 25mm - Textilene rope - Polyester cushion 4cm included, fixed by velcro.

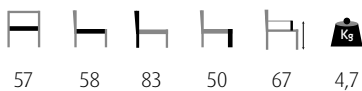

57 58 83 50 67 4,7





Murcia

Cadix

Ensemble - Set



Anthracite
Anthracite



 p302



S21
R17,R18

Structure en aluminium - Peinture époxy : Anthracite - Fauteuils : épaisseur tube pieds 2mm ; diamètre tube pieds 30mm -
Table : épaisseur tube 1,6mm ; diamètre tube 30mm - Corde Textilène - Coussins polyester inclus.

Aluminum frame - Powder coating : Anthracite - Armchairs : leg tube thickness 2mm ; legs tube diameter 30mm -
Table : tube thickness 1,6mm ; tube diameter 30mm - Textilene rope - Polyester cushions included.



74	73	73	45	60	9,2	Fauteuil 1 place <i>One-Seater</i>
150	73	73	45	60	15,4	Fauteuil 2 places <i>Two-Seater</i>



110x53	40	3,7	Table basse <i>Low table</i>
--------	----	-----	--------------------------------





Cadix

Denia

New

Fauteuil - Armchair



Terra
Terra

Sable
Sand



 p303



S29,S30
R29,R30

Structure en aluminium - Peinture époxy - Épaisseur tube 1,3mm - Diamètre tube 32mm - Tressage PE rond effet corde.
Aluminum frame - Powder coating - Tube thickness 1,3mm - Tube diameter 32mm - Round PE rope look.



57 61 76 45 65 3,1



ISO 4892-3:2016 Cycle 1
ISO 105-A02:1993/Cor.2:2005



Denia

Alicante

New

Tabouret - Barstool



Terra
Terra

Sable
Sand



 p303



S29,S30
R29,R30

Structure en aluminium - Peinture époxy - Épaisseur tube 1,3mm - Diamètre tube 32mm - Tressage PE rond effet corde.
Aluminum frame - Powder coating - Tube thickness 1,3mm - Tube diameter 32mm - Round PE rope look.

      
54 57 106 75 3,3



ISO 4892-3:2016 Cycle 1
ISO 105-A02:1993/Cor.2:2005



Alicante

Javea

New

Fauteuil - *Armchair*



Paille
Straw



 p303



S1+R1

Structure en acier - Peinture époxy : Anthracite - Epaisseur tube 1,4mm - Diamètre tube 19mm - Tressage PE torsadé 5mm.
Steel frame - Powder coating : Anthracite - Tube thickness 1,4mm - Tube diameter 19mm - Twisted PE rattan 5mm.

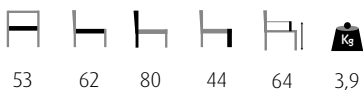



Javea

Amsterdam

Fauteuil - *Armchair*



Paille
Straw



Olive
Olive



Anthracite
Anthracite



 p303



S1+R1
S1+R2
S1+R3

Structure en aluminium - Peinture époxy : Anthracite - Épaisseur tube 32x1,2mm à 19x2mm - Tressage PE torsadé 5mm.
Aluminum frame - Powder coating : Anthracite - Tube thickness 32x1,2mm to 19x2mm - Twisted PE Rattan 5mm.





Amsterdam

Breda

Tabouret - Barstool



Paille
Straw



Olive
Olive



Anthracite
Anthracite



 p303



S1+R1
S1+R2
S1+R3

Structure en aluminium - Peinture époxy : Anthracite - Épaisseur tube 32x1,2mm à 19x2mm - Tressage PE torsadé 5mm.
Aluminum frame - Powder coating : Anthracite - Tube thickness 32x1,2mm to 19x2mm - Twisted PE Rattan 5mm.

46 58 104 76 3,2





Breda

Savana

Stock
Limité
Limited
Stock

Fauteuil - Armchair



Paille
Straw

Olive
Olive



 p303



S1+R1
S1+R2

Structure en acier - Peinture époxy : Anthracite - Épaisseur tube 1mm - Diamètre tube 22mm - Tressage PE torsadé 5mm.
Steel frame - Powder coating : Anthracite - Tube thickness 1mm - Tube diameter 22mm - Twisted PE rattan 5mm.

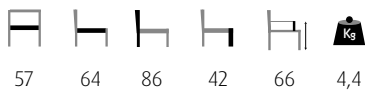



Savana

Saint-Raphaël

New

Fauteuil - Armchair



Anthracite
Anthracite

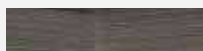

 p303



S26
R26

Structure en aluminium - Peinture époxy : Anthracite - Épaisseur tube avant 38x17x1,2mm; tube arrière 25x1,5mm - Tressage TPU rond effet corde.

Aluminum frame - Powder coating : Anthracite - Tube thickness: front 38x17x1,2mm; rear tube 25x1,5mm - Round TPU wicker rope look.

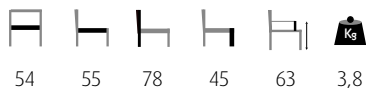

  
ASTM G154-23 9_{max}



Saint-Raphaël

Concorde

Stock
Limité
Limited
Stock

Fauteuil - *Armchair*



Anthracite
Anthracite

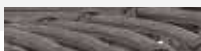

 p302

Structure en aluminium - Peinture époxy : Anthracite - Épaisseur tube 1,5mm - Diamètre tube 28mm - Corde textilène anthracite.
Aluminum frame - Powder coating : Anthracite - Tube thickness 1,5mm - Tube diameter 28mm - Anthracite textilene rope.

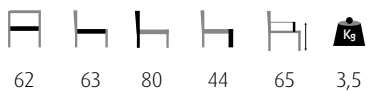

62 63 80 44 65 3,5





Concorde

Odéon

New

Chaise - Chair



Crème & Vert
Cream & Green

Blanc & Camel
White & Camel

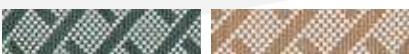

 p302



S31
R31,R32

Structure en aluminium - Peinture époxy : Bamboo look clair - Épaisseur tube 1,5mm - Diamètre tube 28mm - Textilène 8x8.
Aluminum frame - Powder coating : Light Bamboo look - Tube thickness 1,5mm - Tube diameter 28mm - Textilene 8x8.

      
48 56 85 46 3,9





Odéon

Bercy

New

Fauteuil - Armchair



Crème & Vert
Cream & Green

Blanc & Camel
White & Camel

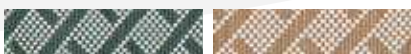

p302



S31
R31,R32

Structure en aluminium - Peinture époxy : Bamboo look clair - Épaisseur tube 1,5mm -Diamètre tube 28mm - Textilène 8x8.
Aluminum frame - Powder coating : Light bamboo look - Tube thickness 1,5mm - Tube diameter 28mm - Textilene 8x8.

57 59 77 46 66 3,5

12^{max}



Bercy

Limoges

New

Chaise - Chair



Gris & Blanc
Grey & White



 p302



S5
R28

Structure en aluminium - Peinture époxy : Bamboo look clair - Épaisseur tube 1,5mm - Diamètre tube 28mm - Textilène 8x8.
Aluminum frame - Powder coating : Light bamboo look - Tube thickness 1,5mm - Tube diameter 28mm - Textilene 8x8.



51 59 86 46 4





Limoges

Reims

Chaise - Chair







Gris & Beige
Grey & Beige



 p302  S22
R19

Structure en aluminium - Peinture époxy : Bamboo look chestnut - Épaisseur tube 1,5mm - Diamètre tube 28mm - Textilène 4x4.
Aluminum frame - Powder coating : Bamboo look chestnut- Tube thickness 1,5mm - Tube diameter 28mm - Textilene 4x4.

    
49 55 85 47 3

  6max



Reims

Blois

Fauteuil - Armchair



Gris & Beige
Grey & Beige



 p302



S22
R19

Structure en aluminium - Peinture époxy : Bamboo look chestnut - Tube avant : épaisseur 2mm ; diamètre 24mm -
Tube arrière : épaisseur 1,5mm ; diamètre 28mm - Textilène 4x4.

Aluminum frame - Powder coating : Bamboo look chestnut - Front tube : thickness 2mm ; diameter 24mm - Rear tube :
thickness 1,5mm ; diameter 28mm - Textilene 4x4.

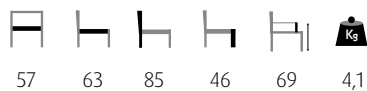



Blois

Dole

Tabouret - Barstool



Gris & Beige
Grey & Beige







 p302



S22
R19

Structure en aluminium - Peinture époxy : Bamboo look chestnut - Épaisseur tube 1,5mm - Diamètre tube 28mm - Textilène 4x4.
Aluminum frame - Powder coating : Bamboo look chestnut - Tube thickness 1,5mm - Tube diameter 28mm - Textilene 4x4.

   
45 60 76 2,9





Dole

Paris

Chaise - Chair

New



STRUCTURE
FRAME

Bamboo Look Clair
Light Bamboo Look

New



Bamboo Look Foncé
Dark Bamboo Look



TRESSAGE
WICKER

Noir & Blanc
Black & White

New



Noir
Black



Bordeaux & Crème
Bordeaux & Cream



Vert & Crème
Green & Cream



i p302



S32,S6
R33,R13,R14,R15

Structure en aluminium - Peinture époxy : Bamboo look - Épaisseur tube 1,5mm - Diamètre tube 28mm - Textilène 8x8.
Aluminum frame - Powder coating : Bamboo look - Tube thickness 1,5mm - Tube diameter 28mm - Textilene 8x8.

41 56 90 44 3,4 Kg





Paris

Montmartre

Fauteuil - *Armchair*



Noir
Black



 p302



S6
R13

Structure en aluminium - Peinture époxy : Bamboo look foncé - Épaisseur tube 1,5mm - Diamètre tube 28mm - Textilène 8x8.
Aluminum frame - Powder coating : Dark Bamboo look - Tube thickness 1,5mm - Tube diameter 28mm - Textilene 8x8.

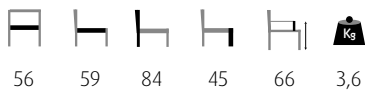

56 59 84 45 66 3,6





Montmartre

Drouot

Stock
Limité
Limited
Stock

Chaise - Chair



Noir & Gris Clair
Black & Light Grey



 p302



S2
R11

Structure aluminium - Peinture époxy : Noir - Épaisseur tube 1,5mm - Diamètre tube 28mm - Textilène 8x8.
Aluminum frame - Powder coating : Black - Tube thickness 1,5mm - Tube diameter 28mm - Textilene 8x8.





Drouot

Trocadero

Fauteuil - Armchair



Noir & Gris Clair
Black & Light Grey



 p302



S2
R11

Structure aluminium - Peinture époxy : Noir - Épaisseur tube 1,5mm - Diamètre tube 28mm - Textilène 8x8.
Aluminum frame - Powder coating : Black - Tube thickness 1,5mm - Tube diameter 28mm - Textilene 8x8.

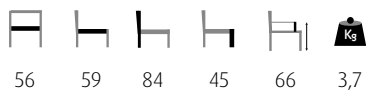

56 59 84 45 66 3,7





Trocadero

Villette

Stock
Limité
Limited
Stock

Chaise - Chair



Noir
Black







 p302-303



S5
R9

Structure en aluminium - Peinture époxy : Bamboo look clair - Épaisseur tube 1,5mm - Diamètre tube 28mm - Tressage PE.
Aluminum frame - Powder coating : Light Bamboo look - Tube thickness 1,5mm - Tube diameter 28mm - PE Wicker.

    
46 57 88 46 3,6





Villette

Madeleine

Stock
Limité
Limited
Stock

Fauteuil - *Armchair*



Noir
Black



 p302-303



S5
R9

Structure en aluminium - Peinture époxy : Bamboo look clair - Épaisseur tube 1,5mm - Diamètre tube 28mm - Tressage PE.
Aluminum frame - Powder coating : Light Bamboo look - Tube thickness 1,5mm - Tube diameter 28mm - PE wicker.

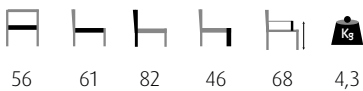



Madeleine

Dauphine

Stock
Limité
Limited
Stock

Fauteuil - *Armchair*



Noir
Black



 p302



S2
R4

Structure aluminium - Peinture époxy : Noir - Tube avant 28x1,35mm et tube arrière 25x1,35mm - Textilène 2x2.
Aluminum frame - Powder coating : Black - Front tube 28x1,35mm and rear tube 25x1,35mm - Textilene 2X2.

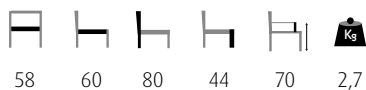



Dauphine

Bastille

Chaise - Chair



Terra
Terra

 Sauge
Sage

 Anthracite
Anthracite



 p302



S33,S34,S7

Structure en acier - Peinture époxy - Effet texturé - Épaisseur tube 1,5mm - Diamètre tube 22mm.
Steel frame - Powder coating - Textured effect - Tube thickness 1,5mm - Tube diameter 22mm.

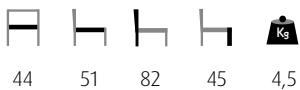

  
ISO 4892-3:2016



Bastille

Bastille Bst

Tabouret - Barstool



Terra
Terra

New

Sauge
Sage

New

Anthracite
Anthracite



 p302



S33,S34,S7

Structure en acier - Peinture époxy - Effet texturé - Épaisseur tube 1,5mm - Diamètre tube 22mm.
Steel frame - Powder coating - Textured effect - Tube thickness 1,5mm - Tube diameter 22mm.



53 56 96 75 6,7

  
ISO 4892-3:2016 δ_{max}



Bastille Bst

Pigalle

Table - Table

New



New

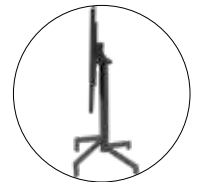

Terra
Terra

New Sauge
Sage

New Anthracite
Anthracite



i p303



S33,S34,S7

Pied de table en aluminium - Encastrable - Système basculant - Plateau en tôle d'acier - Peinture époxy - Effet texturé.
Aluminum table base - Stackable - Folding mechanism - Steel sheet table top - Powder coating - Textured effect.



60x60 42x42 75,5 41x103 8

2000 cycles   



Pigalle

Doha

New

Fauteuil Lounge - Lounge Armchair



Anthracite
Anthracite

Taupe
Taupe

Sauge
Sage

Terra
Terra



p303



S17,S18
S19,S20

Monobloc polypropylène
Polypropylene monobloc

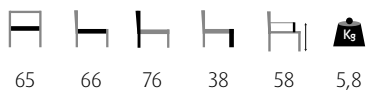



Doha

Cairo

New

Table Basse - *Low table*



Anthracite
Anthracite

Taupe
Taupe

Saugé
Sage

Terra
Terra



p303

S17,S18
S19,S20

Polypropylène - Vérins de réglage.
Polypropylene - Adjustable footplugs.

44x43 47x45 41 2,6 70

10^{max}



Cairo

Dubai

Chaise - Chair



Anthracite
Anthracite

Taupe
Taupe





Sauge
Sage

Terra
Terra



 p303  S17,S18
S19,S20

Monobloc polypropylène.
Polypropylene monobloc.

    
51 57 78 45 4,2

   10_{max}



Dubai

Jeddah

Fauteuil - *Armchair*



Anthracite
Anthracite

Taupe
Taupe

Sauge
Sauge

Terra
Terra



 p303

 S17,S18
S19,S20

Monobloc polypropylène.
Polypropylene monobloc.





Jeddah

Oman

Tabouret - *Barstool*



Anthracite
Anthracite

Taupe
Taupe

Sauge
Sage

Terra
Terra



 p303



S17,S18
S19,S20

Monobloc polypropylène.
Polypropylene monobloc.





Oman

Penelope

Chaise - Chair



Noir
Black



Marsala
Marsala



 p303



Monobloc polypropylène renforcé avec fibre de verre.
Polypropylene monobloc reinforced with fiberglass.

    
50 59 84 47 4,2

CATAS
Test report
343113





Penelope

Ulysse

Fauteuil - Armchair



Noir
Black

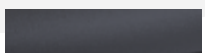

Marsala
Marsala



 p303



Monobloc polypropylène renforcé avec fibre de verre.
Polypropylene monobloc reinforced with fiberglass.

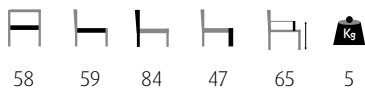

58 59 84 47 65 5

CATAS
Test report
343116





Ulysse

Achille Bar 75

New

Tabouret - Barstool



Noir

Black

Marsala

Marsala



 p303



Monobloc polypropylène renforcé avec fibre de verre.
Polypropylene monobloc reinforced with fiberglass.



CATAS
Test report
363230



6max



Achille Bar 75

Tom Bar 75

Tabouret - Barstool



Noir
Black

Marsala
Marsala

Olive
Olive



 p303



Polypropylène renforcé avec fibre de verre.
Polypropylene reinforced with fiberglass.



34 42 75 4

CATAS
Test report
344047





Tom Bar 75

Monna

Chaise - Chair



Noir
Black



Olive
Olive



Octane
Octane



Moutarde
Mustard



 p303



Monobloc polypropylène renforcé avec fibre de verre.
Polypropylene monobloc reinforced with fiberglass.

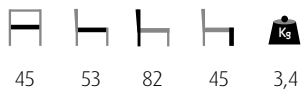

CATAS
Test report
276554





Monna

Sky Pro

Fauteuil - Armchair



Noir
Black

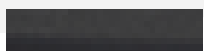

Olive
Olive



 p303



Monobloc polypropylène renforcé avec fibre de verre.
Polypropylene monobloc reinforced with fiberglass.

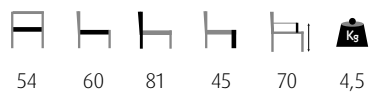

CATAS
Test report
326232





Sky Pro

Maya

Chaise - Chair



Noir
Black



Olive
Olive



Gris Foncé
Dark Grey



Blanc
White



 p303



Monobloc polypropylène.
Polypropylene monobloc.

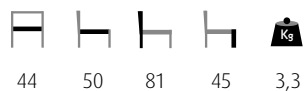

44 50 81 45 3,3

CATAS
Test report
73610





Maya

Maya Bar 75

Tabouret - Barstool



Noir
Black



Olive
Olive



Gris Foncé
Dark Grey



Blanc
White

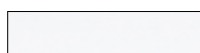

 p303



Monobloc polypropylène.
Polypropylene monobloc.

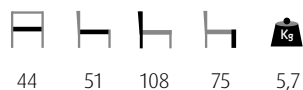

44 51 108 75 5,7

CATAS
Test report
236234





Maya Bar 75

Atlantic

Fauteuil - *Armchair*



Noir
Black



 p303



Monobloc polypropylène renforcé avec fibre de verre - Textilène Serge Ferrari 2x2.
Polypropylene monobloc reinforced with fiberglass - Serge Ferrari Textilene 2x2.

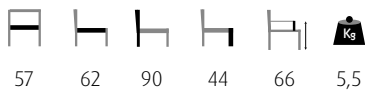

 Serge Ferrari

 CATAS
Test report
308018





Atlantic

Marcel

Chaise - Chair



Noir
Black

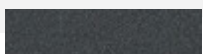

 p303



Monobloc polypropylène renforcé avec fibre de verre.
Polypropylene monobloc reinforced with fiberglass.

    
45 52 85 44 3,5

CATAS
Test report
294903





Marcel

Marcel XL

Fauteuil - Armchair







Noir
Black



 p303



Monobloc polypropylène renforcé avec fibre de verre.
Polypropylene monobloc reinforced with fiberglass.

57 52 85 44 68 3,9

CATAS
Test report
294887





Marcel XL

Marcel Bar 75

Tabouret - Barstool



Noir
Black

 p303



Polypropylène renforcé avec fibre de verre.
Polypropylene reinforced with fiberglass.



CATAS
Test report
294883





Marcel Bar 75

Daytona

Chaise - Chair







Gris Foncé
Dark Grey

 p303



Monobloc polypropylène renforcé avec fibre de verre - Imitation rotin.
Polypropylene monobloc reinforced with fiberglass - Rattan look.

    
53 60 82 46 3,5

CATAS
Test report
201747



 6max



Daytona

Panama

Fauteuil - *Armchair*



Gris Foncé
Dark Grey

 p303



Monobloc polypropylène renforcé avec fibre de verre - Imitation rotin.
Polypropylene monobloc reinforced with fiberglass - Rattan look.

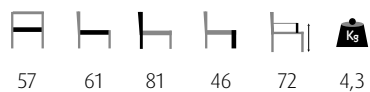

57 61 81 46 72 4,3

CATAS
Test report
201753





Panama

Jamaica

Chaise - Chair



Gris Foncé
Dark Grey

 p303



Monobloc polypropylène renforcé avec fibre de verre - Imitation rotin.
Polypropylene monobloc reinforced with fiberglass - Rattan look.

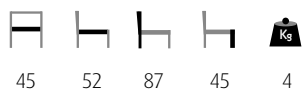

CATAS
Test report
144188





Jamaica

Jamaica F

Fauteuil - *Armchair*



Gris Foncé
Dark Grey

 p303



Monobloc polypropylène renforcé avec fibre de verre - Imitation rotin.
Polypropylene monobloc reinforced with fiberglass - Rattan look.



CATAS
Test report
127165





Jamaica F

Jamaica Bst

Tabouret - *Barstool*



Gris Foncé
Dark Grey

 p303



Monobloc polypropylène renforcé avec fibre de verre - Imitation rotin.
Polypropylene monobloc reinforced with fiberglass - Rattan look.

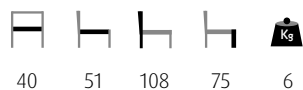

40 51 108 75 6

CATAS
Test report
157230





Jamaica Bst

Kys

Table - Table







Noir
Black

 p303



Résine renforcée par une structure métallique - Encastrable - Système basculant - Vérins de réglage.
Resin reinforced by a metallic frame - Stackable - Fliptop mechanism - Adjustable foot plugs.

   
60x60 74 47x100 7,3





Kys

Kys Bar

Table haute - *High table*



Noir
Black



 p303



Résine renforcée par une structure métallique - Encastrable - Système basculant - Vérins de réglage.
Resin reinforced by a metallic frame - Stackable - Fliptop mechanism - Adjustable foot plugs.



60x60 108 47x134 7,5





Kys Bar

Modena

New

Pied de table - *Table base*

Système basculant - *Fliptop mechanism*



Poignée: Facile à porter.
Handle: Easy to carry.



2 crochets pour suspendre les sacs.
2 hooks for hanging bags.



Encastrable: Facile à ranger.
Stackable: Easy to store.



Modena Double: Facile à basculer.
Modena double: Easy to flip.



Modena 3



Modena Double

Noir Mat
Matt Black



S13

Base et tube en aluminium - Peinture époxy - Système basculant en polyamide - Vérins de réglage - Anneau antivol (sauf Modena Double).

Aluminum Base and tube - Powder coating - Polyamide fliptop mechanism - Adjustable footplugs - Anti-theft ring (except Modena Double).

Modena 3

58	72	Ø60 mm	Ø60	4,6	1,5

Modena Double

95x50	72	Ø60 mm	100x60	120x80	7,1



ISO 9227:2022

New

Modena

Pied de table - Table base

Système antivol - Anti-theft mechanism



Anneau antivol en PVC.
PVC anti-theft ring.

ACCESSOIRES



Câble vrillé avec fils d'acier de Ø4 mm recouverts d'une gaine PVC. Longueurs disponibles : 6 ou 9 m.
Twisted cable with Ø4 mm steel wires covered by a PVC sheath. Available lengths : 6 or 9 m.



Cadenas à 4 chiffres (37x13x44mm)
4-digit padlock



Modena 4



Modena 4 Bar



S11,S13

Anthracite*
Anthracite*

Noir Mat
Matt Black

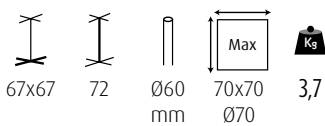

Modena 4

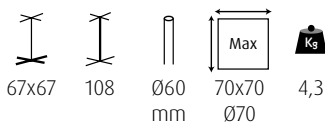

Modena 4 Bar

Base et tube en aluminium - Peinture époxy - Système basculant en polyamide - Vérins de réglage - Anneau antivol.
Aluminum Base and tube - Powder coating - Polyamide fliptop mechanism - Adjustable footplugs - Anti-theft ring.

*Uniquement pour Modena 4 & Modena 4 Bar.
*Only for Modena 4 & Modena 4 Bar.



Kyoto

New

Pied de table - Table base



Kyoto 4



Kyoto 4 Bar

Noir Mat
Matt Black



S13

Base et tube en aluminium - Peinture époxy - Système basculant
Système autostabilisant - Anneau antivol - Contre-poids.

Aluminum Base and tube - Powder coating - Polyamide fliptop
mechanism - Self-stabilizing system - Anti-theft ring - Extra weight.



ISO 9227:2022

Kyoto 4

					Contrepoids Extraweight Kg
68x68	72	Ø60 mm	80x80 Ø100	6,7	2,5

Kyoto 4 Bar

					Contrepoids Extraweight Kg
68x68	108	Ø60 mm	70x70 Ø70	7,3	2,5

New

Kyoto

Pied de table - Table base

Piètements autostabilisants - Self-stabilizing tables bases



Système hydraulique **autostabilisant** permettant d'assurer la stabilité des tables en compensant les différences de niveau de sol jusqu'à 12mm.

Self-leveling hydraulic system to ensure table stability by compensating for ground surface differences up to 12mm.



Avant
Before



Après
After

Contre-poids - Extra-weight



Contre-poids de 2,5kg intégré.
Integrated 2,5kg extra-weight.

Système basculant - Fliptop mechanism



Poignée: Facile à porter.
Handle: Easy to carry.



2 crochets pour suspendre les sacs.
2 hooks for hanging bags.



Encastrable: Facile à ranger.
Stackable: Easy to store.

Système antivol - Anti-theft mechanism



Anneau antivol en PVC.
PVC anti-theft ring.

ACCESSOIRES



Câble vrillé avec fils d'acier de Ø4 mm recouverts d'une gaine PVC. Longueurs disponibles : 6 ou 9 m.
Twisted cable with Ø4 mm steel wires covered by a PVC sheath. Available lengths : 6 or 9 m.



Cadenas à 4 chiffres (37x13x44mm)
4-digit padlock

Monza

Pied de table - *Table base*



Monza



Monza Bar

Anthracite
Anthracite



S11

Base et tube en aluminium - Peinture époxy - Vérins de réglage.
Aluminium base and tube - Powder coating - Adjustable footplugs.



ISO 9227:2017

Monza



63x63



73

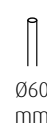

Ø60
mm



Max
70x70
Ø70



4

Contrepoids
Extraweight
Kg

1,5

Monza Bar

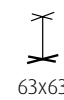

63x63



108

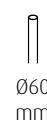

Ø60
mm

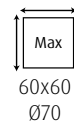

Max
60x60
Ø70



5,8

Contrepoids
Extraweight
Kg

3



Monza

Berlin

Pied de table - *Table base*



Berlin 2



Berlin 4

Noir
Black



S13

Base et tube en aluminium - Peinture époxy - Vérins de réglage.
Aluminium base and tube - Powder coating - Adjustable footplugs.



ISO 9227:2017

Berlin 2



60x68



73

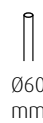

Ø60
mm



Min
100x60



Max
120x80



Kg
4,5

Berlin 4



66x66



73

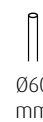

Ø60
mm

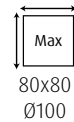

Max
80x80
Ø100



Kg
6,1

Contrepoids
Extraweight
Kg

1,5

Berlin

Pied de table - *Table base*



Berlin 4 Bar

66x66	108	Ø60 mm	70x70 Ø70	6,6	3
				Contrepoids Extraweight Kg	

Berlin 4 Bar



S13

Noir
Black



Base et tube en aluminium - Peinture époxy - Vérins de réglage.
Aluminium base and tube - Powder coating - Adjustable footplugs.



ISO 9227:2017

Empire

Pied de table - *Table base*



Empire 3



Empire 4



Empire 4 Bar

Noir
Black



S12

Aluminium forgé noir - Peinture époxy - Vérins de réglage.
Cast aluminum - Powder coating - Adjustable footplugs.



Empire 3				
----------	--	--	--	--

Empire 4				
----------	--	--	--	--

Empire 4 Bar				
--------------	--	--	--	--

Empire

Pied de table - *Table base*



Empire 2



Empire Grande

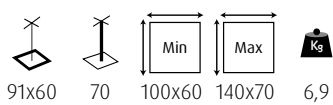

Empire 2



S12

Noir
Black



Aluminium forgé noir - Peinture époxy - Vérins de réglage.
Cast aluminum - Powder coating - Adjustable footplugs.

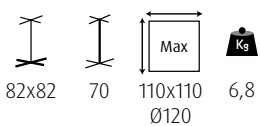

Empire Grande



Bistrot

Pied de table - *Table base*



Bistrot 3 H43



Bistrot 3

Noir
Black



S15

Fonte d'acier* - Epoxy noir - Vérins de réglage.
Cast iron* - Powder coated in black - Adjustable footplugs.



⚠ *Ces articles peuvent rouiller en utilisation extérieure.
*These items may rust when used outdoor.

Bistrot 3 H43

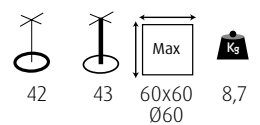

Bistrot 3

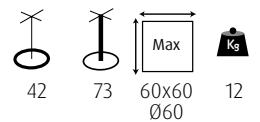

Bistrot

Pied de table - *Table base*



Bistrot 4



Bistrot 3 Bar

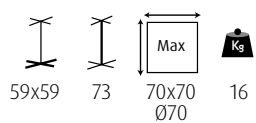

Bistrot 4

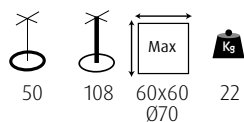

Bistrot 3 Bar



S15

Noir
Black

Fonte d'acier* - Epoxy noir - Vérins de réglage.
Cast iron* - Powder coated in black - Adjustable footplugs.



*Ces articles peuvent rouiller en utilisation extérieure. ⚠️
*These items may rust when used outdoor.

Orsay

New

Table - Table

⚠ Table complète : pied & plateau ne peuvent être vendus séparément.
Complete table : base & top cannot be sold separately.



PLATEAU
TOP

Marbre Blanc - Laiton
White Marble - Brass









PIED
BASE

Noir
Black



Pied en fonte d'acier* - Système basculant - Plateau diamètre 60cm et épaisseur 30mm : plateau compact 5mm imitation marbre et contreplaqué mélaminé 22mm - Cerclage doré en acier inoxydable 201 galvanisé - Vérins de réglage.

Cast iron base* - Folding mechanism - Top diameter 60cm and thickness 30mm : 5mm HPL top with 22mm melamine plywood - Golden galvanized stainless steel 201 ring - Adjustable foot plugs.

     
60 46 75 106x37 16,6

⚠ *Cet article peut rouiller en utilisation extérieure.
*This item may rust when used outdoor.





Orsay

Compact Easy 12mm

New

Plateau de table - Table top



Alaska Oak
694

New



Black Meteor
11

New



Padova
804

New

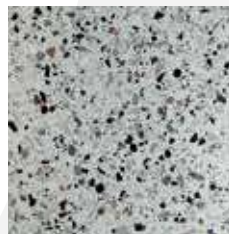

Terrazzo
669

New



Marmo Griggio
671



Grafito
918



Slate
658



Corten
406



Marmo Bianco
654

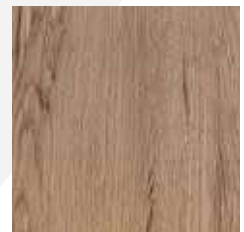

Colorado
459

	
cm	65x65
12 mm	5,8kg

Plateau compact 12mm - Chants droits - Système de fixation universel (visserie fournie) - Protection UV.

12mm HPL top - Straight edges - Universal fixing system (screws included) - UV resistant.



Compact
Easy

⚠ Risque de décoloration des couleurs foncées au soleil.
Risk of dark colors fading if sun exposure.

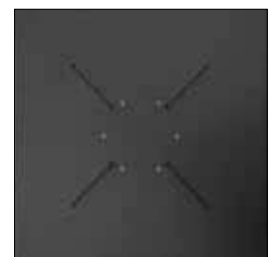

Inserts pour Verona + rails pour autre système de fixation en croix.

Inserts for Verona + grooves for other cross fixing systems.



Compact Easy

Stratifié Moulé Classic

New

Plateau de table - Table top



Basalt
5810

New



Hausmann
4723

New



Granit Light
5807

New



Avalon Pine
4729

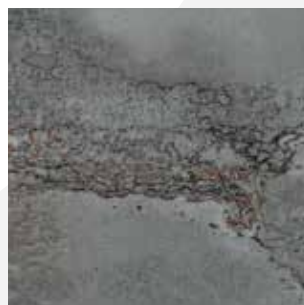

Irony
9687



Malaga
5766

	□		○
cm	60x60	70x70	Ø60
32 mm	5,9kg	8kg	5,3kg

Plateau stratifié moulé - Chant 32mm.

Molded laminated top - 32mm edges.



⚠ Risque de décoloration des couleurs foncées au soleil.
Risk of dark colors fading if sun exposure.





Stratifié Moulé Classic

Stratifié Moulé Cerclé

Plateau de table - *Table top*

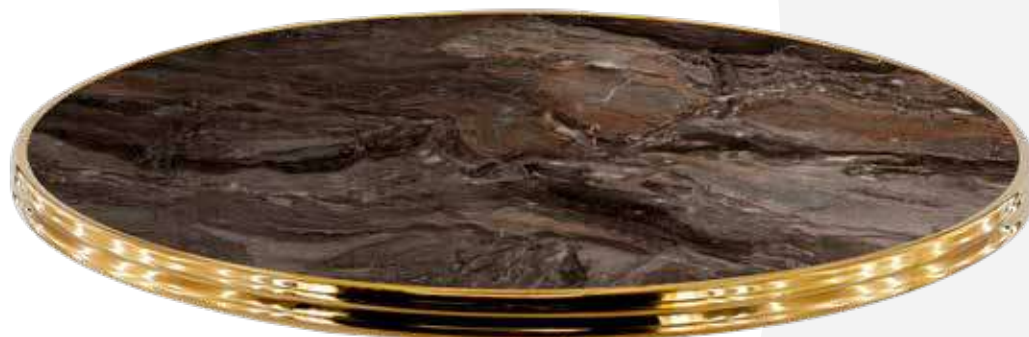

Marrakesh
5717



Mermer
5410

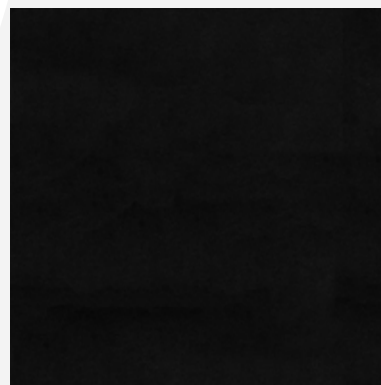

Black Siyah
3190



Laiton
Brass

	○
cm	Ø60
30 mm	4,9kg

Plateau stratifié moulé - Cerclage métallique finition laiton - Chant 30mm.

Rimmed table top - Brass finish metal band - 30mm edges.



⚠ Risque de décoloration des couleurs foncées au soleil.
Risk of dark colors fading if sun exposure.

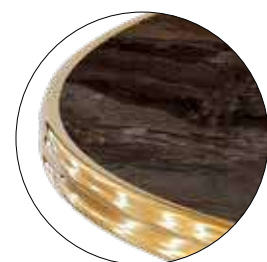



Stratifié Moulé Cerclé





Intérieur - Indoor

Eloïse

New

Chaise - Chair



Greige 05
Greige 05

Terra 56
Terra 56

Vert 75
Green 75

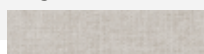

 p306

DAVIS
Wind

ABRASION TEST
30.000-40.000

BS 5852/0
EN 1021/1

Structure en hêtre teinté noir - Assise et dos garnis de tissu WIND.
Black stained beech frame - Seat and back upholstered with WIND fabric.



49 55 81 49 6





Eloïse

Romeo

New

Fauteuil - Armchair



Greige 05
Greige 05

Terra 56
Terra 56

Vert 75
Green 75

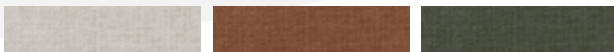

p306

DAVIS
Wind

ABRASION TEST
30.000-40.000

BS 5852/0
EN 1021/1

Structure en hêtre teinté noir - Assise et dos garnis de tissu WIND.
Black stained beech frame - Seat and back upholstered with WIND fabric.

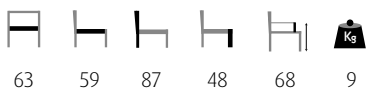

63 59 87 48 68 9





Romeo

Tristan Bst

New

Tabouret - Barstool



Greige 05
Greige 05

Terra 56
Terra 56

Vert 75
Green 75



 p306

DAVIS
Wind

ABRASION TEST
30.000-40.000

BS 5852/0
EN 1021/1

Structure en hêtre teinté noir - Assise et dos garnis de tissu WIND - Repose-pieds en hêtre avec renfort métallique.
Black stained beech frame - Seat and back upholstered with WIND fabric - Beech footrest with metal reinforcement.



52 57 105 77 9





Tristan Bst

Clothilde

New

Chaufeuse - Lounge chair



Greige 05
Greige 05

Terra 56
Terra 56

Vert 75
Green 75

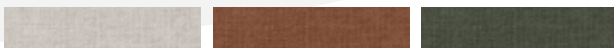

 p306

DAVIS
Wind

ABRASION TEST
30.000-40.000

BS 5852/0
EN 1021/1

Structure en hêtre teinté noir - Assise et dos garnis de tissu WIND.
Black stained beech frame - Seat and back upholstered with WIND fabric.

    
70 72 78 43 13,3





Clothilde

Ginette

New

Chaise - Chair



Greige 05
Greige 05

Gris Foncé 88
Dark Grey 88



 p306

DAVIS
Sorella

ABRASION TEST
60.000-70.000

BS 5852/0
EN 1021/1

Structure en hêtre teinte noire - Assise et dos garnis de tissu SORELLA.
Black stained beech frame - Seat and back upholstered with SORELLA fabric.



60 59 84 49 6





Ginette

Angèle

New

Chaise - Chair



Greige 05
Greige 05

Gris Foncé 88
Dark Grey 88



 p306

DAVIS
Sorella

ABRASION TEST
60.000-70.000

BS 5852/0
EN 1021/1

Structure en hêtre teinté noir - Assise et dos garnis de tissu SORELLA.
Black stained beech frame - Seat and back upholstered with SORELLA fabric.



55 56 77 50 7





Angèle

Marius Bst

New

Tabouret - Barstool



Greige 05
Greige 05

Gris Foncé 88
Dark Grey 88

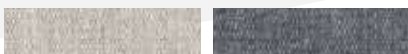

 p306

DAVIS
Sorella

ABRASION TEST
60.000-70.000

BS 5852/0
EN 1021/1

Structure en hêtre teinté noir - Assise et dos garnis de tissu SORELLA - Repose-pieds en hêtre avec renfort métallique.
Black stained beech frame - Seat and back upholstered with SORELLA fabric - Beech footrest with metal reinforcement.



52 57 105 77 9





Marius Bst

Eugénie

New

Chaufeuse - Lounge chair



Greige 05
Greige 05

Gris Foncé 88
Dark Grey 88



 p306

DAVIS
Sorella

ABRASION TEST
60.000-70.000

BS 5852/0
EN 1021/1

Structure en hêtre teinté noir - Assise et dos garnis de tissu SORELLA.
Black stained beech frame - Seat and back upholstered with SORELLA fabric.

    
70 72 78 43 13,3





Eugénie

Simone

Chaise - Chair



Vert 39
Green 39



Terra 59
Terra 59



Gris Clair 83
Light Grey 83



 p307

DAVIS
Aragon

ABRASION TEST
45.000-60.000

BS 5852/0
EN 1021/1

WATER
REPELLENT

Structure en métal noir - Épaisseur tube 1,8mm - Diamètre tube 16mm - Assise et dossier garnis de tissu ARAGON.
Black metal frame - Tube thickness 1,8mm - Tube diameter 16mm - Upholstered seat and back with ARAGON fabric.

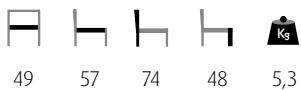



Simone

René

Fauteuil - Armchair



Vert 39
Green 39



Terra 59
Terra 59



Gris Clair 83
Light Grey 83



 p307







DAVIS
Aragon

ABRASION TEST
45.000-60.000

BS 5852/0
EN 1021/1



Structure en métal noir - Épaisseur tube 1,8mm - Diamètre tube 16mm - Assise et dossier garnis de tissu ARAGON.
Black metal frame - Tube thickness 1,8mm - Tube diameter 16mm - Upholstered seat and back with ARAGON fabric.

      
57 50 76 48 73 6,5





René

Auguste

Tabouret - *Barstool*



Vert 39
Green 39



Terra 59
Terra 59



Gris Clair 83
Light Grey 83



 p307





DAVIS
Aragon

ABRASION TEST
45.000-60.000

BS 5852/0
EN 1021/1

WATER
REPELLENT

Structure en métal noir - Épaisseur tube 2mm - Diamètre tube 19mm - Assise et dossier garnis de tissu ARAGON.
Black metal frame - Tube thickness 2mm - Tube diameter 19mm - Upholstered seat and back with ARAGON fabric.

    
51 55 108 78 8,4





Auguste

Mélina

Chaise - Chair



Gris 18
Grey 18



 p307

DAVIS
Gava

ABRASION TEST
>100.000

BS 5852/0
EN 1021/1

WATER
REPELLENT

RECYCLED
POLYESTER

Structure en métal noir - Épaisseur tube 1,5mm - Diamètre tube 19mm - Assise et dossier garnis de tissu GAVA.
Black metal frame - Tube thickness 1,5mm - Tube diameter 19mm - Upholstered seat and back with GAVA fabric.

    
55 58 75 48 5,4





Mélina

Sandra

Tabouret - Barstool



Gris 18
Grey 18



 p307

DAVIS
Gava

ABRASION TEST
>100.000

BS 5852/0
EN 1021/1

WATER
REPELLENT

RECYCLED
POLYESTER

Structure en métal noir - Épaisseur tube 1,5mm - Diamètre tube 19mm - Assise et dossier garnis de tissu GAVA.
Black metal frame - Tube thickness 1,5mm - Tube diameter 19mm - Upholstered seat and back with GAVA fabric.

    
53 56 104 79 6





Sandra

Noëlia

Chaise - Chair



Gris 10/Noir
Grey 10/Black



 p308

fab
Brego

ABRASION TEST
30.000

Structure en métal noir - Épaisseur tube: dossier 1,8mm/pieds 2,5mm - Diamètre tube 16mm - Assise garnie de tissu BREGO - Dossier en contre-plaqué, garni en PVC imitation cannage naturel.

Black metal frame - Tube thickness: back 1,8mm/legs 2,5mm - Diameter tube 16mm - Seat upholstered in BREGO fabric - Plywood backrest with PVC imitation natural caning.

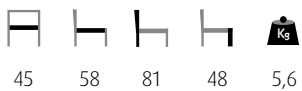



Noëlia

Zoé

Chaise - Chair

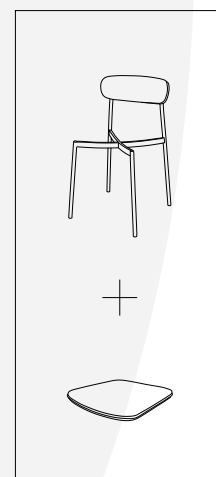

STRUCTURE - FRAME

Noir & Bois Naturel
Black & Natural Wood



Blanc & Bois Naturel
White & Natural Wood

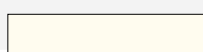

ASSISE - SEAT

Gris Brun 056
Grey Brown 056



Olive 144
Olive 144



Orange 106
Orange 106



Beige 032
Beige 032



p308

Miss

ABRASION TEST
>40.000

Structure en métal - Épaisseur tube 2mm - Diamètre tube 19mm - Assise en contre-plaqué, garnie de tissu MISS - Dossier en contre-plaqué.

Metal frame - Tube thickness 2mm - Tube diameter 19mm - Plywood seat upholstered in MISS fabric - Plywood back.

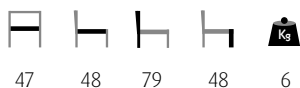

47 48 79 48 6





Zoé

Ralph

Tabouret - *Barstool*

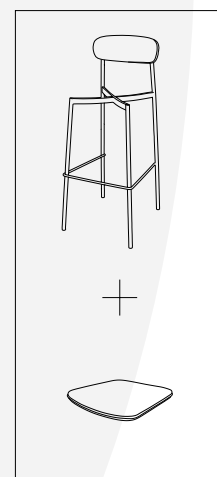

STRUCTURE - FRAME

Noir & Bois Naturel
Black & Natural Wood



Blanc & Bois Naturel
White & Natural Wood

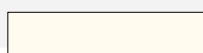

ASSISE - SEAT

Gris Brun 056
Grey Brown 056



Olive 144
Olive 144



Orange 106
Orange 106



Beige 032
Beige 032



p308

Miss

ABRASION TEST
>40.000

Structure en métal - Épaisseur tube 2mm - Diamètre tube 19mm - Assise en contre-plaqué, garnie de tissu MISS - Dossier en contre-plaqué.

Metal frame - Tube thickness 2mm - Tube diameter 19mm - Plywood seat upholstered in MISS fabric - Plywood back.



42 48 106 78 6,8





Ralph

Mikka

Chaise - Chair



Cuoio
Cuoio

Anthracite
Anthracite



 p308







 **elastron**
COLORADO

ABRASION TEST
100.000

 **BS 5852/0**
EN 1021/1



Structure en métal noir - Épaisseur tube 1,5mm - Diamètre tube 32mm - Assise et dossier garnis de similicuir PU COLORADO.
Black metal frame - Tube thickness 1,5mm - Tube diameter 32mm - Seat and back upholstered in COLORADO PU faux-leather.

     
56 60 81 48 7,4





Mikka

Olaf

Fauteuil - Armchair



Cuoio
Cuoio



Anthracite
Anthracite



p308

elastron
COLORADO

ABRASION TEST
100.000

BS 5852/0
EN 1021/1



Structure en métal noir - Épaisseur tube 1,5mm - Diamètre tube 32mm - Assise et dossier garnis de similicuir PU COLORADO.
Black metal frame - Tube thickness 1,5mm - Tube diameter 32mm - Seat and back upholstered in COLORADO PU faux-leather.

Kg
57 59 87 48 66 6,8





Olaf

Jacob

Chaise - Chair



Cuoio
Cuoio

Anthracite
Anthracite



 p308

 **elastron**
COLORADO

ABRASION TEST
100.000

 **BS 5852/0**
EN 1021/1



Structure en métal noir - Épaisseur tube 1,5mm - Tube 15x30mm - Assise et dossier garnis de similicuir PU COLORADO.
Black metal frame - Tube thickness 1,5mm - Tube 15x30mm - Seat and back upholstered in COLORADO PU faux-leather.





Jacob

Kyle

Tabouret - Barstool



Cuoio
Cuoio

Anthracite
Anthracite



p308

elastron
COLORADO

ABRASION TEST
100.000

BS 5852/0
EN 1021/1



Structure en métal noir - Épaisseur tube 1,5mm - Tube 19x30mm - Assise et dossier garnis de similicuir PU COLORADO.
Black metal frame - Tube thickness 1,5mm - Tube 19x30mm - Seat and back upholstered in COLORADO PU faux-leather.

46 53 106 78 6,1





Kyle

Wendy

Banquette - Bench



Connecteur amovible inclus
Removable connector included



Cuoio
Cuoio

Anthracite
Anthracite



 p308

 **elastron**
COLORADO

ABRASION TEST
100.000

 **BS 5852/0**
EN 1021/1



Structure en métal noir - Épaisseur tube 1,5mm - Tube 30x30mm - Assise et dossier garnis de similicuir PU COLORADO.
Black metal frame - Tube thickness 1,5mm - Tube 30x30mm - Seat and back upholstered in COLORADO PU faux-leather.

120 60 94 48 30





Wendy

Maurice

Chaise - Chair



Cognac
Cognac



Anthracite
Anthracite



EN 1021:1/2

Structure métallique noire - Épaisseur tube 1,5mm - Diamètre tube 28mm - Assise et dos garnis en similicuir PU.
Black metal frame - Tube thickness 1,5mm - Tube diameter 28mm - Seat and back upholstered with PU faux-leather.

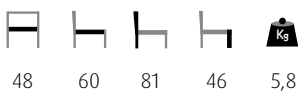



Maurice

Maurice Bst

Tabouret - Barstool



H65

Maurice Bst H65



H79

Maurice Bst H79

Cognac
Cognac



Anthracite
Anthracite



EN 1021:1/2

Structure métallique noire - Épaisseur tube 1,5mm - Diamètre tube 28mm - Assise et dos garnis en similicuir PU.
Black metal frame - Tube thickness 1,5mm - Tube diameter 28mm - Seat and back upholstered with PU faux-leather.



37 50 92 65 6,3 Maurice Bst H65

37 54 107 79 6,8 Maurice Bst H79





Maurice Bst

College

Chaise - Chair



Teinte Brun Vintage
Vintage Brown Stain



Structure en métal finition industrielle, vernis brillant - Épaisseur tube 1,5mm - Diamètre tube 25mm - Assise et dossier en contre-plaqué.

Metal frame industrial finish, glossy varnish - Tube thickness 1,5mm - Tube diameter 25mm - Seat and back in plywood.

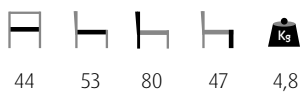



College

Harvard

New

Tabouret - *Barstool*



Teinte Brun Vintage
Vintage Brown Stain



Structure en métal finition industrielle, vernis brillant - Épaisseur tube 1,5mm - Diamètre tube 25mm - Assise et dossier en contre-plaqué.

Metal frame industrial finish, glossy varnish - Tube thickness 1,5mm - Tube diameter 25mm - Seat and back in plywood.

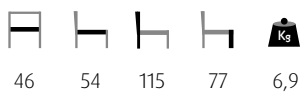

46 54 115 77 6,9





Harvard

Montreal

Fauteuil - Armchair



Marron Vintage
Vintage Brown



Structure en métal noir - Épaisseur tube 40x20x1,2mm - Assise et dossier garnis de similicuir PU.
Black metal frame - Tube thickness 40x20x1,2mm - Seat and back upholstered with PU faux-leather.



52 55 77 46 68 7,5





Montreal

Stanley

Chaise - Chair



Marron Vintage
Vintage Brown

Structure métallique noire - Épaisseur tube 1,5mm - Diamètre tube 19mm - Assise et dos garnis en similicuir PU.
Black metal frame - Tube thickness 1,5mm - Tube diameter 19mm - Seat and back upholstered with PU faux-leather.

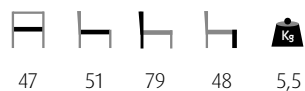

47 51 79 48 5,5





Stanley

Stanley Bst

Tabouret - Barstool



Marron Vintage
Vintage Brown



Structure métallique noire - Épaisseur tube 1,5mm - Diamètre tube 19mm - Assise et dos garnis en similicuir PU.
Black metal frame - Tube thickness 1,5mm - Tube diameter 19mm - Seat and back upholstered with PU faux-leather.





Stanley Bst

Brixton

Fauteuil - *Armchair*



Marron Vintage
Vintage Brown



Structure métallique noire - Accoudoirs en bois - Épaisseur tube 2mm - Diamètre tube 28mm - Assise et dos garnis en similicuir PU.

Black metal frame - Wooden armrests - Tube thickness 2mm - Tube diameter 28mm - Seat and back upholstered with PU faux-leather.

65 78 91 44 65 18,5





Brixton

Soho

Chaise - Chair



Cognac Vintage
Vintage Cognac

Structure métallique noire - Épaisseur tube 1,5mm - Diamètre tube 30mm - Assise et dos garnis en similicuir PU.
Black metal frame - Tube thickness 1,5mm - Tube diameter 30mm - Seat and back upholstered with PU faux-leather.

49 64 88 49 7,2





Soho

Condor

Stock
Limité
Limited
Stock

Fauteuil - *Armchair*



Cognac
Cognac

Anthracite
Anthracite



 p299

Structure métallique noire (en une pièce) - Épaisseur tube 1,2mm - Tube 20x20mm - Assise et dos garnis de tissu SOFTYL.
Black metal frame (in one piece) - Tube thickness 1,2mm - Tube 20x20mm - Seat and back upholstered with SOFTYL fabric.

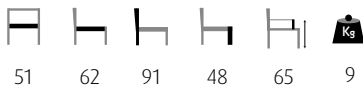



Condor

Cuba

Fauteuil - *Armchair*



Brun Clair 41
Light Brown 41

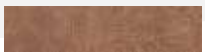

 p308

fab[®]
Cortes

ABRASION TEST
35.000

Structure en hêtre teinté Wengé - Assise et dos garnis de tissu Vintage CORTES.
Wenge stained beech frame - Seat and back upholstered with CORTES vintage fabric.

72 69 70 43 67 16,8





Cuba

Cuba Double

Fauteuil - Armchair



Brun Clair 41
Light Brown 41



 p308

fabb
Cortes

ABRASION TEST
35.000

Structure en hêtre teinté Wengé - Assise et dos garnis de tissu Vintage CORTES.
Wenge stained beech frame - Seat and back upholstered with CORTES vintage fabric.

     
119 69 70 43 67 22,3





Cuba Double

Kate

Chaise - Chair

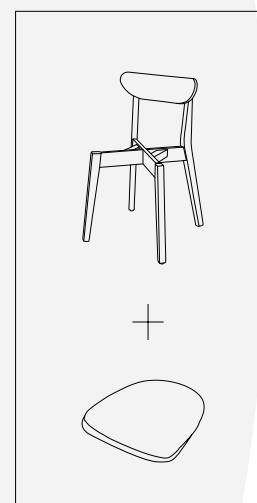

STRUCTURE - FRAME

Teinte Chêne Miel
Honey Oak Stain



Noir
Black



ASSISE - SEAT

Rouille 52
Rusty 52



Vert 34
Green 34



Gris 90
Grey 90



Bleu 75
Blue 75



 p307





DAVIS
Luis

ABRASION TEST
30.000

 EN 1021/1
BS 5852/0

 WATER
REPELLENT

Structure en hêtre teinté - Assise garnie de tissu LUIS.
Stained beech frame - Upholstered seat with LUIS fabric.

44 48 76 49 5,1





Kate

Budapest

Chaise - Chair

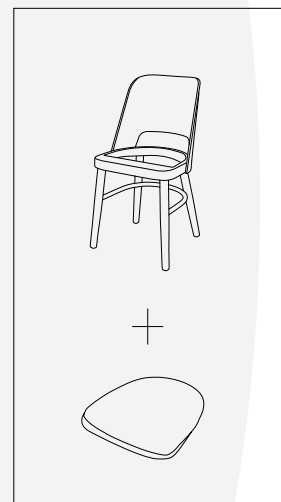

STRUCTURE - FRAME
Teinte Chêne Miel
Honey Oak Stain



Bordeaux 5269
Bordeaux 5269



Cappuccino 5582
Cappuccino 5582



Olive 9430
Olive 9430



Teinte Wengé
Wenge Stain



ASSISE - SEAT

Éléphant 5272
Elephant 5272



Terra 9244
Terra 9244



Noir 7006
Black 7006



p309

TEXTUM ABRASION TEST
Lotos >100.000

Structure en hêtre teinté - Assise garnie de similicuir PU LOTOS.
Stained beech frame - Upholstered seat with LOTOS PU faux-leather.

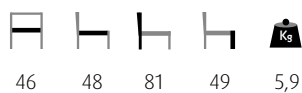



Budapest

Budapest Bst

Tabouret - Barstool

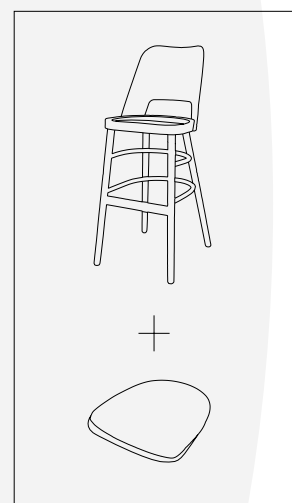

STRUCTURE - FRAME	Teinte Chêne Miel Honey Oak Stain	Bordeaux 5269 Bordeaux 5269	Cappuccino 5582 Cappuccino 5582	Olive 9430 Olive 9430
	Teinte Wengé Wenge Stain	Éléphant 5272 Elephant 5272	Terra 9244 Terra 9244	Noir 7006 Black 7006

ABRASION TEST
Lotos >100.000

Structure en hêtre teinté - Assise garnie de similicuir PU LOTOS - Repose-pieds en hêtre avec renfort métallique.
Stained beech frame - Upholstered seat with LOTOS PU faux-leather - Beech footrest with metal reinforcement.



44 50 113 82 7,7





Budapest Bst

Dimitri

Chaise - Chair

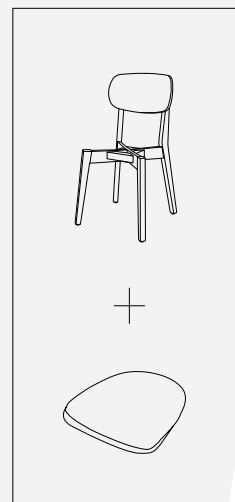

STRUCTURE - FRAME

Teinte Chêne Miel
Honey Oak Stain



ASSISE - SEAT

Noir 7006
Black 7006



 p309

 **TEXTUM** ABRASION TEST
Lotos >100.000

Structure en hêtre teinté - Assise garnie de similicuir PU LOTOS.
Stained beech frame - Upholstered seat with LOTOS PU faux-leather.

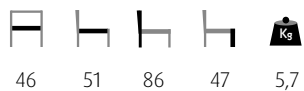

46 51 86 47 5,7





Dimitri

Dimitri Bst

Tabouret - Barstool

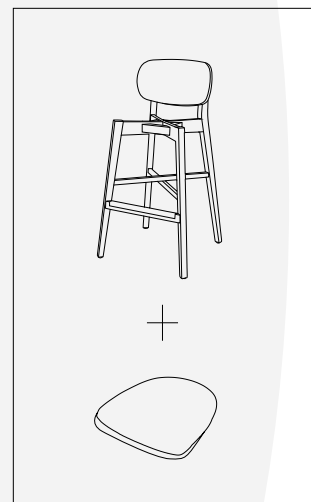

STRUCTURE - FRAME

Teinte Chêne Miel
Honey Oak Stain



ASSISE - SEAT





Noir 7006
Black 7006



 p309

 **ABRASION TEST**
Lotos >100.000

Structure en hêtre teinté - Assise garnie de similicuir PU LOTOS - Repose-pieds en hêtre avec renfort métallique.
Stained beech frame - Upholstered seat with LOTOS PU faux-leather - Beech footrest with metal reinforcement.

     
50 49 102 77 7,4





Dimitri Bst

Brooklyn

Chaise - Chair

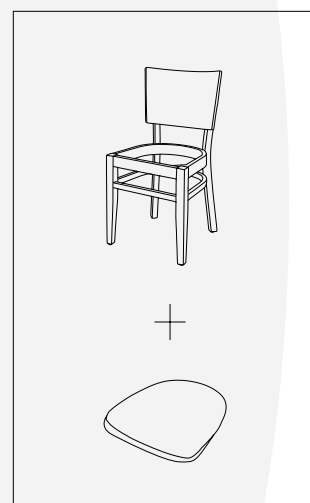

STRUCTURE - FRAME

Teinte Wengé
Wenge Stain

Bordeaux 5269
Bordeaux 5269



Cappuccino 5582
Cappuccino 5582



ASSISE - SEAT

Chocolat 9314
Chocolate 9314



Noir 7006
Black 7006



p309

ABRASION TEST
Lotos >100.000

Structure en hêtre teinté - Assise garnie de similicuir PU LOTOS.
Stained beech frame - Upholstered seat with LOTOS PU faux-leather.

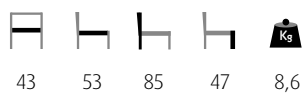



Brooklyn

Brooklyn Bst

Tabouret - Barstool

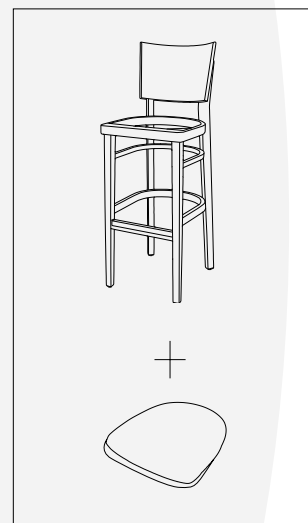

STRUCTURE - FRAME

Teinte Wengé
Wenge Stain

Bordeaux 5269
Bordeaux 5269



ASSISE - SEAT

Chocolat 9314
Chocolate 9314



Cappuccino 5582
Cappuccino 5582



Noir 7006
Black 7006



p309

ABRASION TEST
Lotos >100.000

Structure en hêtre teinté - Assise garnie de similicuir PU LOTOS - Repose-pieds en hêtre avec renfort métallique noir.
Stained beech frame - Upholstered seat with LOTOS PU faux-leather - Beech footrest with black metal reinforcement.





Brooklyn Bst

Pub

Chaise - Chair

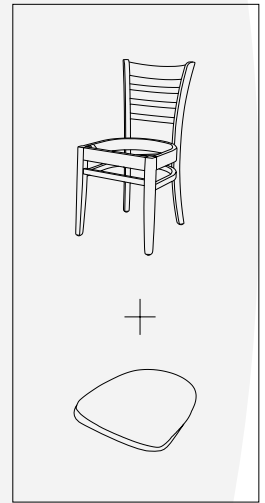

STRUCTURE - FRAME

Teinte Wengé
Wenge Stain

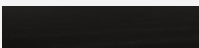

Bordeaux 5269
Bordeaux 5269



ASSISE - SEAT

Chocolat 9314
Chocolate 9314



Cappuccino 5582
Cappuccino 5582



Noir 7006
Black 7006



p309

ABRASION TEST
Lotos >100.000

Structure en hêtre teinté - Assise garnie de similicuir PU LOTOS.
Stained beech frame - Upholstered seat with LOTOS PU faux-leather.



43 53 85 47 6,9





Pub

Pub Bst

Tabouret - Barstool

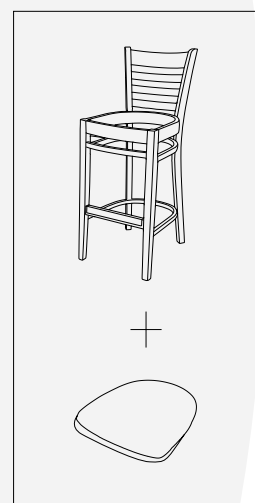

STRUCTURE - FRAME

Teinte Wengé
Wenge Stain

Bordeaux 5269
Bordeaux 5269



ASSISE - SEAT

Chocolat 9314
Chocolate 9314



Cappuccino 5582
Cappuccino 5582



Noir 7006
Black 7006



p309

ABRASION TEST
Lotos >100.000

Structure en hêtre teinté - Assise garnie de similicuir PU LOTOS - Repose-pieds en hêtre avec renfort métallique noir.
Stained beech frame - Upholstered seat with LOTOS PU faux-leather - Beech footrest with black metal reinforcement.

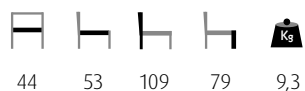



Pub Bst

Palma

New

Chaise - Chair



Brun Foncé
Dark Brown



Structure en hêtre teinté.
Stained beech frame.

42 50 80 48 4,4





Palma

Palma Bst

New

Tabouret - Barstool



Brun Foncé
Dark Brown

Structure en hêtre teinté.
Stained beech frame.

41 43 105 75 5,5





Palma Bst

Sofia

Chaise - Chair



Noir
Black

Brun Foncé
Dark Brown

French Patina
French Patina

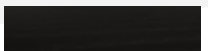

Structure en hêtre teinté.
Stained beech frame.



46 45 87 47 4





Sofia

Sofia Bst

Tabouret - Barstool



Noir
Black

Brun Foncé
Dark Brown

French Patina
French Patina



Structure en hêtre teinté.
Stained beech frame.



46 45 108 76 5,3





Sofia Bst

Emile

Chaise - Chair



Anthracite 92
Anthracite 92

Petrol 76
Petrol 76

Olive 38
Olive 38

Gold 48
Gold 48

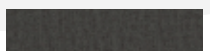

p307

DAVIS
Monolith

ABRASION TEST
>100.000

EN 1021/1
BS 5852/0

WATER
REPELLENT

Structure en hêtre teinté noir - Assise et dossier garnis de velours MONOLITH.
Black stained beech frame - Seat and back upholstered with MONOLITH velvet.



49 55 81 49 6





Emile

Alfonse

Fauteuil - *Armchair*



Anthracite 92
Anthracite 92

Petrol 76
Petrol 76

Olive 38
Olive 38

Gold 48
Gold 48



p307

DAVIS
Monolith

ABRASION TEST
>100.000

EN 1021/1
BS 5852/0

WATER
REPELLENT

Structure en hêtre teinté noir - Assise et dossier garnis de velours MONOLITH.
Black stained beech frame - Seat and back upholstered with MONOLITH velvet.

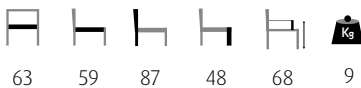

63 59 87 48 68 9





Alfonse

Oscar Bst

Tabouret - Barstool



Anthracite 92
Anthracite 92

Petrol 76
Petrol 76

Olive 38
Olive 38

Gold 48
Gold 48



p307

DAVIS
MONOLITH

ABRASION TEST
>100.000

EN 1021/1
BS 5852/0

WATER
REPELLENT

Structure en hêtre teinté noir - Assise et dos garnis de velours MONOLITH - Repose-pieds en hêtre avec renfort métallique.
Black stained beech frame - Seat and back upholstered with MONOLITH velvet - Beech footrest with metal reinforcement.





Oscar Bst

Lautrec S

Stock
Limité
Limited
Stock

Chaqueuse - Lounge Chair



Anthracite 92
Anthracite 92

Petrol 76
Petrol 76

Olive 38
Olive 38

Gold 48
Gold 48



i p307

DAVIS
Monolith

ABRASION TEST
>100.000

EN 1021/1
BS 5852/0



Structure en hêtre teinté noir - Assise et dossier garnis de velours MONOLITH.
Black stained beech frame - Seat and back upholstered with MONOLITH velvet.





Lautrec S

Arnold

Fauteuil - *Armchair*



Anthracite 92
Anthracite 92

Petrol 76
Petrol 76

Gold 48
Gold 48



p307

DAVIS
Monolith

ABRASION TEST
>100.000

EN 1021/1
BS 5852/0

WATER
REPELLENT

Structure en hêtre - Pieds métalliques noirs - Assise et dossier garnis de velours MONOLITH.
Beech frame - Black metal legs - Seat and back upholstered with MONOLITH velvet.

Kg
78 84 83 49 64 27,5

4 pieds à visser
4 legs to be mounted



Arnold

Willy

Fauteuil - *Armchair*



Anthracite 92
Anthracite 92

Petrol 76
Petrol 76

Gold 48
Gold 48



 p307







DAVIS
Monolith

ABRASION TEST
>100.000

EN 1021/1
BS 5852/0

WATER
REPELLENT

Structure en hêtre - Pieds métalliques noirs - Assise et dossier garnis de velours MONOLITH.
Beech frame - Black metal legs - Seat and back upholstered with MONOLITH velvet.

     
140 84 83 49 64 39

 
4 pieds à visser
4 legs to be mounted



Willy

Floriane II

Chaise - Chair



Taupe 926
Taupe 926

Chocolat 928
Chocolate 928

Noir 9100
Black 9100



 p309

Structure en hêtre teinté Wengé - Assise et dossier garnis de similicuir PU.
Wenge stained beech frame - Seat and back upholstered with PU faux-leather.





Floriane II

Floriane Bst II

Tabouret - *Barstool*



Taupe 926
Taupe 926

Chocolat 928
Chocolate 928

Noir 9100
Black 9100



 p309

Structure en hêtre teinté Wengé - Assise et dossier garnis de similicuir PU - Repose-pieds en métal.
Wenge stained beech frame - Seat and back upholstered with PU faux-leather - Metal footrest.

45 54 111 78 8,5





Floriane Bst II

Clinton

Chaise - Chair







Naturel & Éléphant 5272 Wengé & Noir 7006 Wengé & Pepper 5271
Natural & Elephant 5272 Wenge & Black 7006 Wenge & Pepper 5271



 p309  **ABRASION TEST**
Lotos >100.000

Structure en hêtre teinté - Assise et dossier garnis de similicuir PU LOTOS.
Stained beech frame - Seat and back upholstered with LOTOS PU faux-leather.

    
44 59 89 50 5,8

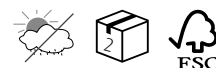



Clinton

Clinton Bst

Tabouret - Barstool



Naturel & Éléphant 5272 Wengé & Noir 7006 Wengé & Pepper 5271
Natural & Elephant 5272 Wenge & Black 7006 Wenge & Pepper 5271



 p309  **ABRASION TEST**
Lotos >100.000

Structure en hêtre teinté - Assise et dossier garnis de similicuir PU LOTOS - Repose-pieds en métal.
Stained beech frame - Seat and back upholstered with LOTOS PU faux-leather - Metal footrest.

    
36 44 100 81 7





Clinton Bst

Maryne

Table basse - *Low table*



Marbre noir
Black marble

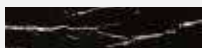

Lot de 2 tables - Structure métallique noire - Épaisseur tube 1,5mm - Diamètre tube 25mm - Plateau mélaminé.
Set of 2 tables - Black metal frame - Tube thickness 1,5mm - Tube diameter 25mm - Melamine top.



Grande/Big A: 90 / B: 80
Petite/Small A: 69 / B: 62



Grande/Big: 37
Petite/Small: 30



Grande/Big: 8,3
Petite/Small: 5,3





Maryne

Jolyne

Table basse - *Low table*



Noir
Black

Mango
Mango



Structure métallique noire - Epaisseur de tube 1,5mm - Tube 15x60mm - Plateau mélaminé - Patins réglables.
Black metal frame - Tube thickness 1,5mm - Tube 15x60mm - Melamine top - Adjustable footplugs.

  
60 42 9,5





Jolyne

Ellen

Table basse - *Low table*



Naturel
Natural



Structure métallique noire - Épaisseur tube 1,2mm - Tube 60x15mm - Plateau mélaminé - Patins réglables.
Black metal frame - Tube thickness 1,2mm - Tube 60x15mm - Melamine top - Adjustable footplugs.

  
60 43 11,7





Ellen

Gallia

New

Pied de table - *Table base*



Gallia 4



Gallia 4 Bar

Noir
Black



S15

Base et tube en fonte d'acier - Peinture époxy - Vérins de réglage.
Cast ironed base and tube - Powder coating - Adjustable footplugs.



Gallia 4

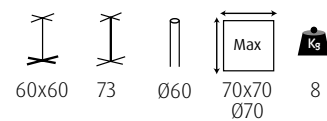

Gallia 4 Bar

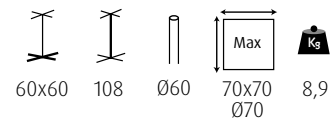

New

Gallia

Pied de table - Table base



Gallia 4 XL



Gallia Double

Noir
Black



S15

					Gallia 4 XL
76x76	73	Ø60	Max 90x90 Ø120	11,2	

						Gallia Double
60	73	Ø60	Min 90x70	Max 140x80	12,5	

Base et tube en fonte d'acier - Peinture époxy - Vérins de réglage.
Cast ironed base and tube - Powder coating - Adjustable footplugs.



Factory

Stock
Limité
Limited
Stock

Pied de table - *Table base*

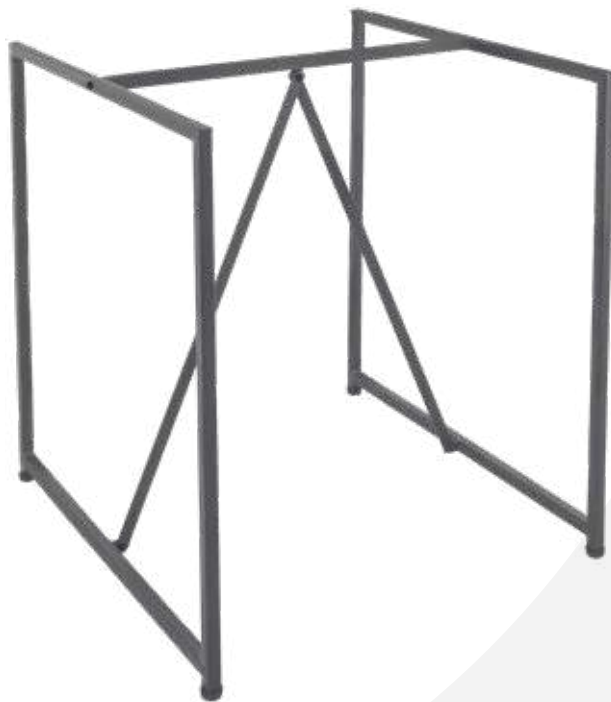

Gun Métal
Gun Metal



S15

Structure métallique - Tube 20x20mm - Épaisseur 2mm - Vérins réglables.

Metal frame - Tube size 20x20mm - Tube thickness 2mm - Adjustable footplugs.



Factory 70

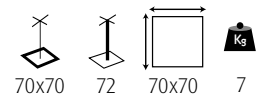

Retro

Pied de table - *Table base*



Retro Small



Retro Large

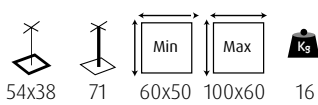

Retro Small

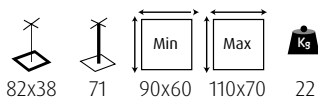

Retro Large



S15

Noir
Black

Fonte d'acier - Epoxy noir - Vérins de réglage.
Cast iron - Powder coated in black - Adjustable footplugs.



Bistrot

Pied de table - *Table base*



Bistrot 3 H43



Bistrot 3

Noir
Black



S15

Fonte d'acier* - Epoxy noir - Vérins de réglage.
Cast iron* - Powder coated in black - Adjustable footplugs.



⚠ *Ces articles peuvent rouiller en utilisation extérieure.
*These items may rust when used outdoor.

Bistrot 3 H43

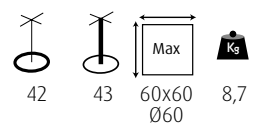

Bistrot 3

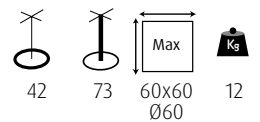

Bistrot

Pied de table - *Table base*



Bistrot 4



Bistrot 3 Bar



S15

Noir
Black

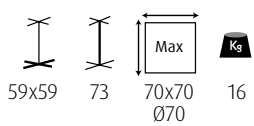

Bistrot 4

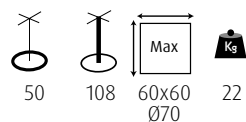

Bistrot 3 Bar

Fonte d'acier* - Epoxy noir - Vérins de réglage.
Cast iron* - Powder coated in black - Adjustable footplugs.



*Ces articles peuvent rouiller en utilisation extérieure. ⚠️
*These items may rust when used outdoor.

Prato

Pied de table - *Table base*



Prato 16



Prato 19



Prato 30

Noir Mat
Matt Black



S14

Fonte d'acier - Epoxy noir mat - Vérins de réglage.
Cast iron - Powder coated in black - Adjustable footplugs.



Prato 16

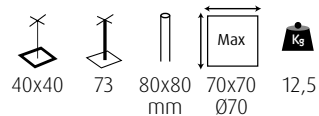

Prato 19

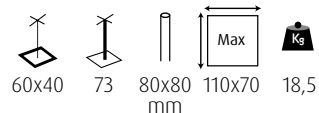

Prato 30

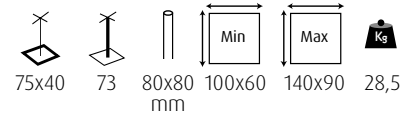

Prato

Pied de table - *Table base*



Prato 16 Bar



Prato 30 Bar

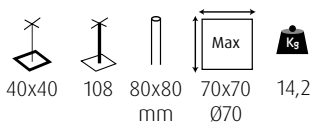

Prato 16 Bar



S14

Noir Mat
Matt Black

Fonte d'acier - Epoxy noir mat - Vérins de réglage.
Cast iron - Powder coated in black - Adjustable footplugs.

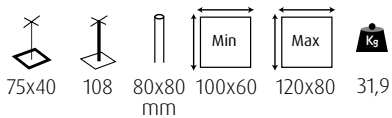

Prato 30 Bar



Prato

Pied de table - Table base



Prato 15



Prato 15 Bar

Noir Mat
Matt Black



S14

Fonte d'acier - Epoxy noir mat - Vérins de réglage.
Cast iron - Powder coated in black - Adjustable footplugs.



Prato 15

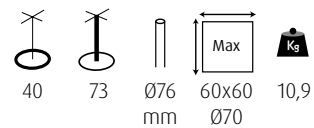

Prato 15 Bar

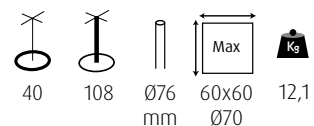

Prato

Pied de table - Table base



Prato 20



Prato 70



S14

Noir Mat
Matt Black

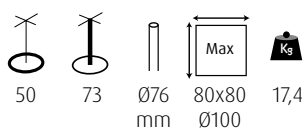

Prato 20

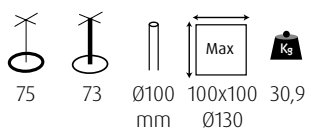

Prato 70

Fonte d'acier - Epoxy noir mat - Vérins de réglage.
Cast iron - Powder coated in black - Adjustable footplugs.



Rome

Pied de table - *Table base*



Rome 05



Rome 06



Rome 05 Bar

Noir
Black



S15

Fonte d'acier - Epoxy noir - Vérins de réglage.
Cast iron - Powder coated in black - Adjustable footplugs.



Rome 05					
Rome 06					
Rome 05 Bar					

Rome

Pied de table - *Table base*



Rome 12



Rome 13



Rome 12 Bar

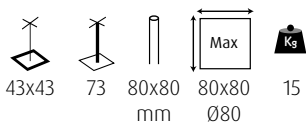

Rome 12



S15

Noir
Black

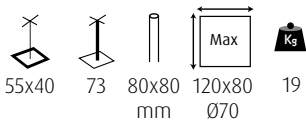

Rome 13

Fonte d'acier - Epoxy noir - Vérins de réglage.
Cast iron - Powder coated in black - Adjustable footplugs.

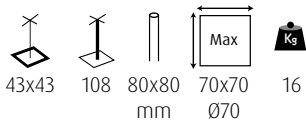

Rome 12 Bar



Stratifié - Laminate

New

Original Collection

Plateau de table - Table top



Noyer
OH251 W06

New



Marbre Samas
3482

New



Marmara
F 160 ST9



Marbre Blanc
OF253 BST

cm	□			▭				○	
	60x60	70x70	80x80	60x70	110x70	120x70	120x80	Ø70	Ø120 *
24mm	6,8kg	8,1kg	10,9kg	7,5kg	12,9kg	14kg	16,2kg	6,4kg	21,3kg

* 26 mm



i p305

Plateau stratifié - Chants en ABS - Disponible en épaisseur 24mm uniquement*.
Laminate table top - ABS edges - Available only in thickness of 24mm*.





Stratifié-Laminate

Original Collection



Stratifié - Laminate

Perfect Sense Collection

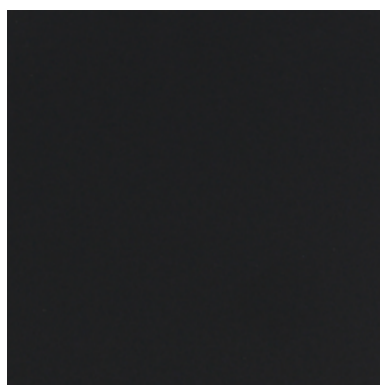
Plateau de table - *Table top*



Noir - *Black*
PT U999

		
cm	60x60 70x70	120x70
20mm	4,8kg 6,5kg	11,2kg



 p305

Plateau stratifié - Chants en ABS - Extra mat - Toucher soyeux - Anti-traces de doigts - Anti-reflets - Disponible en épaisseur 20mm uniquement*.

Laminate table top - ABS edges - Extra matte - Silky touch - Fingerprint proof - Anti-reflective - Available only in thickness of 20mm.*



FINGERPRINT
PROOF

MATTE -
LOW REFLECTIVITY

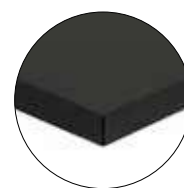



Stratifié-Laminate

Perfect Sense Collection

Stratifié - Laminate

Chêne - Oak Halifax

Plateau de table - Table top



Chêne Halifax Naturel
H 1180 ST37

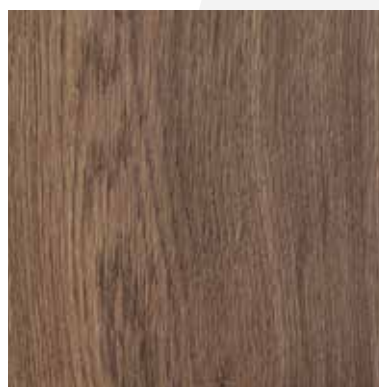

Chêne Halifax Tabac
H1181 ST37

cm	□			▭				○	
	60x60	70x70	80x80	60x70	110x70	120x70	120x80	Ø70*	Ø120*
24mm	5,9kg	8,3kg	10,4kg	7,2kg	12,7kg	13,7kg	16,1kg	6,5kg	19,7kg 26 mm
46mm	8,5kg	10,7kg	13,5kg	9,4kg	15,7kg	17,1kg	19,2kg	/	/

* Uniquement: Naturel H 1180 ST37

* Only: Naturel H 1180 ST37



i p305

Plateau stratifié aspect bois - Chants en ABS imitation « Bois de bout » - Toucher « Feelwood » : suit les fibres du bois.

Laminate table top with wood-like appearance - ABS edges - « Feelwood » touch : realistic look and feel of the wooden fibers.





Stratifié-Laminate

Chêne - Oak Halifax

Mélaminé

Melamine



Plateau de table - Table top



Minnesota Oak Chocolat
H441 Z5L



Chêne Halifax Naturel
H 1180 ST37

			
cm	60x60	70x70	120x70
18mm	4,4kg	6,2kg	11,2kg



 p305

Plateau mélaminé aspect bois - Chants en ABS imitation « Bois de bout »
Toucher « Feelwood » - Epaisseur 18mm.

Melamine table top with wood-like appearance - ABS edges - « Feelwood »
touch - Thickness 18mm.





Mélaminé

Melamine



Odense

Chêne-Oak

Plateau de table - *Table top*



Finition rustique naturelle brossée
Natural rustic brushed finish

			
cm	60x60	70x70	120x70
30mm	8,4kg	11,1kg	19kg



Dessous
Underside

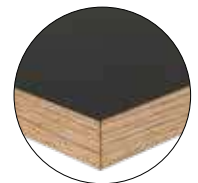

 p305

Plateau bois plaqué chêne - Finition rustique naturelle brossée - 4 couches de vernis polyuréthane satiné - Epaisseur 30mm.

Wooden oak veneered top - Natural rustic brushed finish - 4 coats of polyurethane satin lacquer - Thickness 30mm.

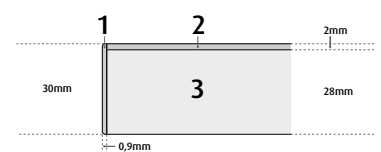

1. Chants plaqués
 2. Plaquage Chêne
 3. Aggloméré
1. Veneer edges
 2. Oak veneer
 3. Chipboard



Odense

Chêne-Oak

William

Buffet - Buffet



Wengé
Wenge

Bardolino
Bardolino



Structure en mélamine - Tablettes en stratifié - 4 roulettes dont 2 avec frein - Porte à droite - Meuble monté - Usage intérieur uniquement.
Melamine structure - Laminated shelves - 4 casters, including 2 with brakes - Door on the right side - Assembled - Indoor use only.

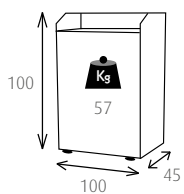



William

Jacky

Meuble poubelle - Waste bin



Wengé
Wenge



Bardolino
Bardolino



ACCESSOIRE

Poubelle PVC 80L
PVC trashbin 80L



80L



Structure en mélamine - Tablette en stratifié - Battant en inox lesté - 4 roulettes dont 2 avec frein - Fermeture à clé - Meuble monté - Usage intérieur uniquement.

Melamine structure - Laminated shelf - Weighted stainless steel flap - 4 casters, including 2 with brakes - Key lock - Assembled - Indoor use only.

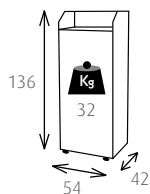



Jacky





Réception - Catering

Tiffany

Stock
Limité
Limited
Stock

Chaise - Chair



Noir Brillant
Glossy Black

Monobloc polypropylène.
Polypropylene monobloc.

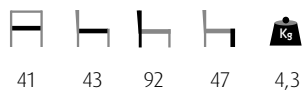



Tiffany

XL 180

Table - Table

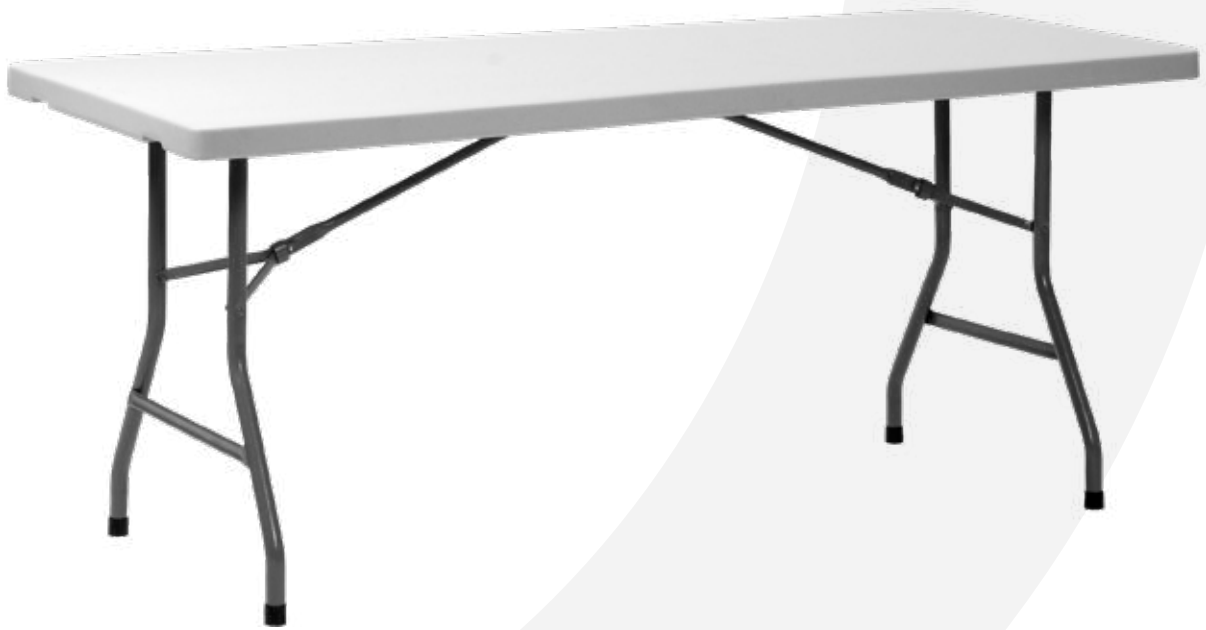

Blanc
White



Piètement métallique pliant - Diamètre tube 28mm - Plateau polyéthylène épaisseur 45mm.
Folding metal table base - Tube diameter 28mm - Polyethylene table top thickness 45mm.



182x75 74 14



Cocktail 80

Table haute - *High table*

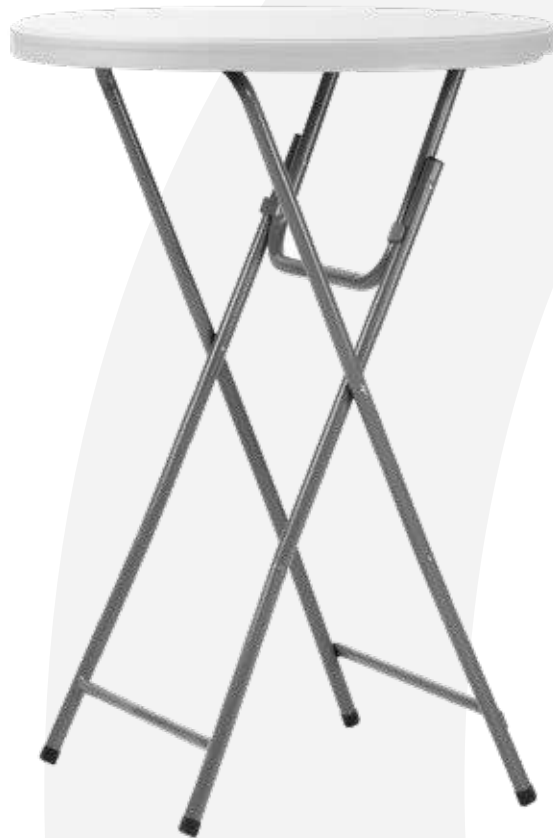

Blanc
White



Piètement métallique pliant - Diamètre tube 22mm - Plateau polyéthylène épaisseur 45mm.
Folding metal table base - Tube diameter 22mm - Polyethylene table top thickness 45mm.



81 110 8

Osaka

Nappe - Cover



Noir
Black



Comprend : 1 nappe + 1 surnappe - Finition stretch 100% polyester - Renforts sur les pieds.
Consists of 1 table cover + 1 topper - 100% stretch polyester - Foot reinforcements.



Pack Cocktail 80 & Osaka

Ensemble - Set



Noir
Black



Ensemble composé de : **1** table Cocktail 80 + **1** nappe + **1** surnappe Osaka - Noir.
Set composed of : **1** Cocktail 80 table + **1** Osaka cover + **1** topper - Black.







Divers - Miscellaneous Info

Informations techniques

Technical information

Textilène - *Textilene*

Fibre de polyester enduite de PVC - *Coated polyester fiber.*

Revêtement textilène - *Textilene covering*



R31
Odéon/Bercy
Crème & Vert
Cream & Green 8x8



R32
Odéon/Bercy
Blanc & Camel
White & Camel 8x8



R28
Limoges
Gris & Blanc
Grey & White 8x8



R19
Reims/Blois/Dole
Gris & Beige
Grey & Beige 4x4

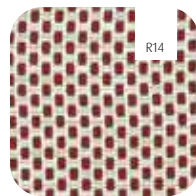

R14
Paris
Bordeaux & Crème
Bordeaux & Cream 8x8

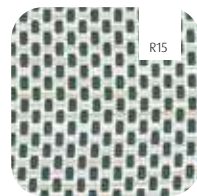

R15
Paris
Vert & Crème
Green & Cream 8x8



R33
Paris
Noir & Blanc
Black & White 8x8

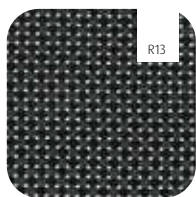

R13
Paris/Montmartre
Noir
Black 8x8



R11
Drouot/Trocadero
Noir & Gris Clair
Black & Light Grey 8x8

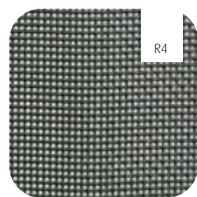

R4
Dauphine
Noir
Black 2x2

Corde textilène - *Textilene rope*



R25
Murcia
Terracotta
Terracotta



R24
Murcia
Noir
Black



R23
Murcia
Taupe
Taupe

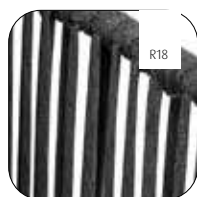

R18
Cadix
Anthracite
Anthracite



R18
Concorde
Anthracite
Anthracite

*Non disponible dans la boîte échantillons
*Not available in the sample box

Bamboo Look - *Bamboo look*



S4
Metz, Dax, Orléans,
Rochelle, Brest, Laval
Bamboo Look Caramel
Caramel Bamboo Look



S5
Limoges, Vilette,
Madeleine
Bamboo Look Clair
Light Bamboo Look



S6
Paris, Montmartre
Bamboo Look Foncé
Dark Bamboo Look

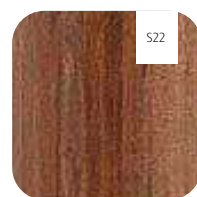

S22
Reims, Blois, Dole
Bamboo Look Chestnut
Chestnut Bamboo Look



S27
Dax
Bamboo Look Foncé
Dark Bamboo Look



S31
Odeon, Bercy
Bamboo Look Clair
Light Bamboo Look



S32
Paris
Bamboo Look Clair
Light Bamboo Look

Métal - *Metal*



S34
Bastille/Bastille Bst/
Pigalle
Saugé
Sage

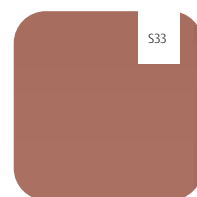

S33
Bastille/Bastille Bst/
Pigalle
Terra
Terra



S7
Bastille/Bastille Bst/
Pigalle
Anthracite
Anthracite



Informations techniques

Technical information

Tressage PE - PE Wicker



R34
Loom/Loyd
Rotin Naturel
Natural Rattan



R16
Metz/Brest/Laval
Rotin Noisette
Nut Rattan

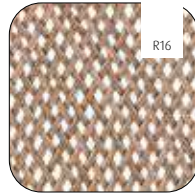

R16
Rochelle/Dax
Rotin Noisette
Nut Rattan

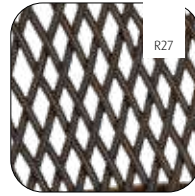

R27
Dax
Rotin Marron foncé
Dark Brown Rattan

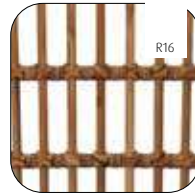

R16
Orléans
Rotin Noisette
Nut Rattan



R30
Denia/Alicante
Sable
Sand 5mm



R29
Denia/Alicante
Terra
Terra 5mm



R30
Denia/Alicante
Sable
Sand 10x5mm



R29
Denia/Alicante
Terra
Terra 10x5mm



S1 R1
Savana/Javea
Paille
Straw Ø5mm



S1 R2
Savana
Olive
Olive Ø5mm



S1 R2
Amsterdam/Breda
Olive
Olive Ø5mm



S1 R1
Amsterdam/Breda
Paille
Straw Ø5mm



S1 R3
Amsterdam/Breda
Anthracite
Anthracite Ø5mm



R26
Saint-Raphaël
Anthracite
Anthracite



R9
Villetta/Madeleine
Noir
Black

Polypropylène - Polypropylene



Monna/Maya/Atlantic/Penelope/
Ulysse/Achille Bar 75/Tom Bar 75/Sky
Pro/Marcel/Marcel XL/Marcel Bst/Kys
Noir Mat
Matte Black



Monna/Maya/Maya Bar
75/Tom Bar/Sky Pro
Olive
Olive



Monna
Moutarde
Moutarde



Monna
Octane
Octane



Penelope/Ulysse/
Achille Bar 75/Tom Bar 75
Marsala
Marsala



Maya/Maya Bar 75
Blanc
White

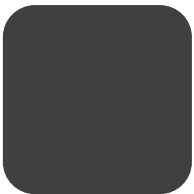

Maya/Maya Bar 75
Gris foncé
Dark Grey



Daytona/Panama/Jamaica
Jamaica F/Jamaica Bst
Gris Foncé
Dark Grey



Doha/Cairo/Dubai
Jeddah/Oman
Anthracite
Anthracite



Doha/Cairo/Dubai
Jeddah/Oman
Taupe
Taupe



Doha/Cairo/Dubai
Jeddah/Oman
Sauge
Sage



Doha/Cairo/Dubai
Jeddah/Oman
Terra
Terra

*Non disponible dans la boîte échantillons
*Not available in the sample box



Doha/Cairo/Dubai/Jeddah/Oman :
CEN/TR 581-4:2005 ; ISO 4892-2:2013/Amd. 1:2021 Cycle 1 ; ISO 4628-2:2016 ; ISO 4628-4:2016 ; ISO 4628-5:2016 ; ISO 4628-6:2011
Résistance aux UV - UV Resistant

Informations techniques

Technical information

Compact Easy - *Compact Easy*

Chants droits - Système de fixation universel.
Straight edges - Universal fixing system.



Colorado
459



Corten
406



Grafito
918



Marmo Bianco
654



Marmo Griggio
671



Slate
658

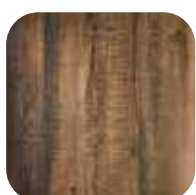

Alaska Oak
694



Black Meteor
11



Padova
804



Terrazzo
669

Stratifié Moulé Classique - *Molded Laminated Classic*

Plateau stratifié moulé.
Molded laminated top.



Avalon Pine
4729



Irony
9687

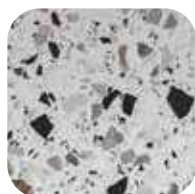

Malaga
5766



Basalt
5810



Hausmann
4723

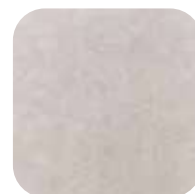

Granit Light
5807

Stratifié Moulé Cerclé - *Molded Laminated Rimmed*

Plateau stratifié moulé
Cerclage métallique finition laiton.
Rimmed table top - Brass finish metal band.



Marrakesh
5717

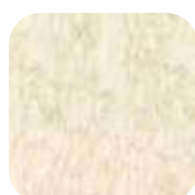

Mermer
5410



Black Siyah
3190

Informations techniques

Technical information

Tables Basses - Low Tables

Plateau mélaminé.
Melamine table top.



Maryne
Marbre noir
Black marble



Jolyne
Mango
Mango



Jolyne
Noir
Black



Ellen
Naturel
Natural

Stratifié Perfect Sense Collection - Laminate Perfect Sense Collection



Plateau stratifié - Chants en ABS - Extra mat - Touché soyeux -
Anti-traces de doigts - Anti-reflets.

Laminate table top - ABS edges - Extra matte - Silky touch -
Fingerprint proof - Anti-reflective.



Noir - Black
PT U999

Stratifié Original Collection - Laminat Original collection



Plateau stratifié - Chants en ABS (Acrylonitrile Butadiène Styrene).
Molded laminated top - ABS (Acrylonitrile Butadiene Styrene) edges.



Marbre Blanc
OF253 BST

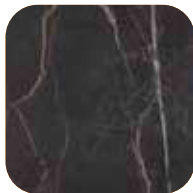

Marbre Samas
3482



Marmara
F 160 ST9

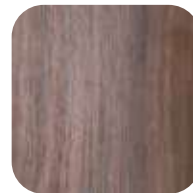

Noyer
OH251 W06

Stratifié Chêne - Laminat Oak Halifax



Plateau stratifié aspect bois touché «feelwood» - Chants en ABS (Acrylonitrile Butadiène Styrene) imitation bois de bout.
«Feelwood» wood-look laminated top - ABS (Acrylonitrile Butadiene Styrene) edges.

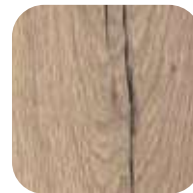

Chêne Halifax Naturel
H1180 ST37

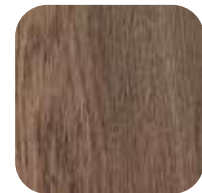

Chêne Halifax Tabac
H1181 ST37

Mélaminé - Melamine



Plateau mélaminé aspect bois touché «feelwood» - Chants en ABS (Acrylonitrile Butadiène Styrene) imitation bois de bout.
«Feelwood» wood-look melamine top - ABS (Acrylonitrile Butadiene Styrene) edges.



Chêne Halifax Naturel
H1180 ST37



Minnesota Oak Chocolat
H441 Z5L

Odense



Bois plaqué chêne - 4 couches de vernis polyuréthane satiné.
Oak veneered wood - 4 coats of polyurethane satin lacquer.



Finition rustique naturelle brossée
Natural rustic brushed finish

Informations techniques

Technical information

Revêtements - Upholstery

Entretien

Le nettoyage et l'entretien réguliers des tissus d'ameublement prolongent leur durée de vie et empêchent la formation de salissures permanentes. Une solution d'eau et de savon doux peut être utilisée pour nettoyer le tissu.

Conservation

Le boulochage des tissus est un processus naturel et peut ne pas être complètement éliminé. L'exposition à la lumière UV et aux sources de chaleur peut provoquer une décoloration du tissu (ceci concerne principalement les couleurs intenses). Pour des raisons technologiques, la teinte d'un tissu peut différer d'un ton par rapport à l'échantillon présenté dans le catalogue. Les photos sont non contractuelles. Les tissus sont conformes aux exigences du règlement européen sur les produits chimiques dangereux (REACH) n° 1907/2006, annexe XVII.

Nettoyage

Étape 1: Enlevez soigneusement l'excès de saleté.

Étape 2: Imbibez la tache d'eau froide et épongez-la avec une serviette en papier.

Étape 3: Laissez sécher.

Maintenance

Regular cleaning and maintenance of upholstery fabrics prolongs their life and prevents the formation of permanent soiling. A mild soap and water solution can be used to clean the fabric.

Preservation

Pilling of fabrics is a natural process and may not be completely eliminated. Exposure to UV light and heat sources can cause discoloration of the fabric (this applies mainly to dark colours). For technological reasons, the shade of a fabric may differ by one shade from the sample shown in the catalog. Photos are non-contractual. Fabrics comply with the requirements of the European regulation on hazardous chemicals (REACH) n° 1907/2006, annex XVII.

Cleaning

Step 1: Carefully remove excess dirt.

Step 2: Soak the stain in cold water and blot with a paper towel.

Step 3: Allow to dry.

Wind • Eloise, Romeo, Tristan Bst, Clothilde



Greige 05
Greige 05



Terra 56
Terra 56



Vert 75
Green 75

Composition

100% Polyester

Poids - Weight

230 g/m² (+/-5%)

Test Martindale

30.000-40.000 tours min.

Largeur rouleau

Usable width of roll

140 cm.



BS 5852
EN 1021/1



DAVIS
FABRICS

www.davis.pl/kolekcja/wind

Sorella • Ginette, Angèle, Marius Bst, Eugénie



Greige 05
Greige 05



Gris Foncé 88
Dark Grey 88

Composition

100% Polyester

Poids - Weight

350 g/m²

Test Martindale

60.000/70.000 tours min

Largeur rouleau

Usable width of roll

140 cm.



BS 5852
EN 1021/1



DAVIS
FABRICS

www.davis.pl/kolekcja/sorella

Aragon • Simone, René, Auguste



Vert 39
Green 39



Terra 59
Terra 59



Gris Clair 83
Light Grey 83

Composition
5% NY
95% PES

Poids - *Weight*
340 g/m² (+/-5%)

Test Martindale
45.000-60.000 tours min.

Largeur rouleau
Usable width of roll
140 cm.

www.davis.pl/kolekcja/aragon



Gava • Mélina, Sandra



Gris 18
Grey 18

Composition
100% Recycled PES

Poids - *Weight*
450 g/m²

Test Martindale
>100.000 tours min

Largeur rouleau
Usable width of roll
140 cm.

www.davis.pl/kolekcja/gava



Luis • Kate



Vert 34
Green 34



Bleu 75
Blue 75



Gris 90
Grey 90



Rouille 52
Rusty 52

Composition
100% PES

Poids - *Weight*
350 g/m²

Test Martindale
20.000-30.000 tours min.

Largeur rouleau - *Usable width of roll*
140 cm.

www.davis.pl/kolekcja/luis



Monolith • Emile, Alfonse, Oscar Bst, Lautrec S, Arnold, Willy



Anthracite 92
Anthracite 92



Burgundy 69
Burgundy 69



Gold 48
Gold 48



Petrol 76
Petrol 76



Olive 38
Olive 38

Composition
100% PES

Poids - *Weight*
330g/m³ (+/-5%)

Test Martindale
>100.000 tours min.

Largeur rouleau
Usable width of roll
140 cm.

www.davis.pl/kolekcja/monolith



Informations techniques

Technical information

Revêtements - Upholstery

Miss • Zoé, Ralph



Beige 032
Beige 032



Gris/Brun 056
Brown/Grey 056



Olive 144
Olive 144



Orange 106
Orange 106

Composition
96% PES 4%NY

Poids - Weight
410g/m²

Test Martindale
40.000 tours min.

Largeur rouleau
Usable width of roll
142 cm.



Brego • Noëlia



Gris 10
Grey 10

Composition
100% PES

Poids - Weight
380g/m²

Test Martindale
30.000 tours min

Largeur rouleau
Usable width of roll
140 cm.



www.fabb.pl/brego-collection

Colorado • Mikka, Olaf, Jacob, Kyle, Wendy



Cuoio
Cuoio



Anthracite
Anthracite

Composition
100% PU
81% PES + 15% Cotton
+ 4% Viscose

Poids - Weight
630g/m² (+/-5%)

Test Martindale
>250.000 tours min.

Largeur rouleau
Usable width of roll
140 cm.



BS 5852/0
EN 1021/1



www.elastrongroup.com/en/upholstery/fabrics/colorado

Cortes • Cuba, Cuba Double



Brun Clair 41
Light Brown 41

Composition
100% PES

Poids - Weight
330g/m²

Test Martindale
35.000 tours min.



www.fabb.pl/cortes-collection

Lotos • Budapest, Budapest Bst, Dimitri, Dimitri Bst, Brooklyn, Brooklyn Bst, Pub, Pub Bst, Clinton, Clinton Bst



Olive 943
Olive 9430



Terra 9244
Terra 9244



Noir 7006
Black 7006



Éléphant 5272
Elephant 5272



Cappuccino 5582
Cappuccino 5582



Bordeaux 5269
Bordeaux 5269

Composition
100% PU

Poids - *Weight*
392g/m² (+/-5%)

Test Martindale
>100.000 tours min.

Largeur rouleau
Usable width of roll
140 cm.



www.textum-stoffe.com/products-detail.html?fabric_name=Lotos

PU • Floriane II, Floriane Bst II



Chocolat 928
Chocolate 928



Noir 9100
Black 9100



Taupe 926
Taupe 926

Composition
66% PU
30% PES
1,3% CV
2,7% COT

Poids - *Weight*
340g/m² (+/-5%)

Test Martindale
100.000 tours min.

Largeur rouleau
Usable width of roll
144 cm.



Softyl • Condor



Anthracite
Anthracite

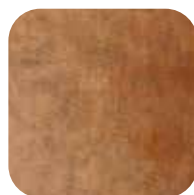

Cognac
Cognac

Composition
100% PES

Poids - *Weight*
360g/m²

Test Martindale
45.000 tours min.

Informations techniques

Technical information

Non-feu

PVC Classement Non-feu - Normes EN 1021 partie 1 (EN 1021/1) ou EN 1021 partie 2 (EN 1021/2)
PVC fire resistant rating - Standards EN 1021 part 1 (EN 1021/1) or EN 1021 part 2 (EN 1021/2)



Méthode de test:

Un banc d'essai est construit à l'aide de mousse et de tissu pour simuler une chaise.

1. Méthode de test - Partie 1: Une cigarette est allumée et placée dans la crevasse du banc de test en contact avec le dossier et le siège. Elle se consume sur toute sa longueur. Le tissu est observé par rapport à la couvaison ou l'inflammation.
2. Méthode de test - Partie 2: Le banc de test composé est à présent testé avec une flamme au butane, qui simule une allumette allumée, dans la crevasse. Après avoir retiré la flamme, le tissu est observé pour voir s'il couve ou s'enflamme dans les 2 min.
3. Résultat: Le matériau de test réussit le test s'il n'y a pas eu d'inflammation ou en cas de zone de combustion limitée.

Test method:

A test rig is constructed using foam and fabric in order to simulate a chair.

1. Test method - Part 1: A cigarette is lit and placed in the crevice of the test rig which is in contact with the backrest and the seat. The cigarette is left to smoulder while the reaction of the tissue is being observed during the process of combustion and inflammation.
2. Test method - Part 2: The test rig is now tested with a butane flame, which simulates a burning match, placed into the crevice. After removing the flame, the reaction of the tissue is being observed to see if it smoulders or ignites within 2 minutes.
3. Result: The test material passes the test if there is no evidence of ignition or if the smouldering site is within the limited acceptable size.

PVC Classement Non-feu - Norme BS 5852 source 0
PVC fire resistant rating - Standard BS 5852 source 0

Méthode de test:

Un banc d'essai est construit pour simuler une chaise avec le tissu à tester. Ce banc est soumis à différentes sources d'allumage. Il y a 8 types de sources d'allumage, chacune avec une intensité de chaleur différente. Elles sont classées de 1 à 8, avec une intensité qui double par rapport à la source précédente.

1. Méthode de test - Source 0: Cigarette qui se consume. Une cigarette est placée le long de la crevasse du banc de test et peut brûler sur toute sa longueur.
Si aucune inflammation ou couvaison progressive n'est observée sur la couverture et le matériau intérieur, le test est enregistré comme étant sans allumage et le matériau réussit le test.
2. Résultat: Le matériau de test réussit le test s'il n'y a pas eu d'inflammation ou en cas de zone de combustion limitée.

Test method:

A test rig is constructed in order to simulate a chair with the fabric to be tested. This rig is subjected to different ignition sources. There are 8 types of ignition sources, each with different heat intensity. They are classified from 1 to 8, the intensity doubling the precedent source.

1. Test method Source 0: A smouldering cigarette. It is lit and placed in the crevice of the test rig and is left to smoulder. If no combustion or inflammation is observed on the cover and the inner material, the test is recorded as no ignition and the material passes the test.
2. Result: The test material passes the test if there is no evidence of ignition or if smouldering site is within the limited acceptable size.

Stratifié/Méla miné - *Laminate/Melamine*



Méla miné
Melamine



Stratifié
Laminate

Comparatif *Comparison*

Résistance à la chaleur:

Le stratifié est plus résistant à la chaleur et sera donc conseillé dans le cas d'une utilisation avec service de plats chauds à table.

Réaction au feu:

Méla miné: M3 Stratifié: M2

Résistance à l'usure:

Le stratifié comprend une couche de protection, pas le méla miné.

Résistance aux coups/chocs:

Le stratifié comprend une couche support en résine, pas le méla miné ; le méla miné est appliqué directement sur le panneau aggloméré.

Prix:

Le stratifié est sensiblement plus cher que le méla miné.

Heat resistance:

Laminate is more resistant to heat and is therefore advised for use with hot plates.

Reaction to fire:

Melamine: M3 Laminate: M2

Wear resistance:

Laminate has a protective coating and melamine does not.

Stock/Impact resistance:

Laminate has an additional layer of resin while the melamine is directly applied to the chipboard.

Price:

Laminate is significantly more expensive than melamine.

Composition *Composition*

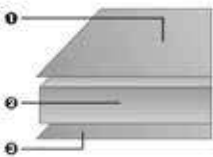

Méla miné
Melamine

Un film de méla miné est appliqué sur le panneau aggloméré à pression et température élevées. Ce film comprend un papier de base trempé dans de la résine de méla miné. Il peut être imprimé ou non et son poids peut varier. Un papier plus lourd peut absorber plus de résine, de sorte que la couche de méla miné est aussi plus épaisse.

1. Feuille de papier décoratif, imprégnée de résine de méla miné.
2. Panneau aggloméré.
3. Feuille de papier décoratif, imprégnée de résine de méla miné.

A melamine film is pressed onto the chipboard at high pressure and temperature. This film consists of a paper substrate saturated with melamine resin. This paper may or may not be printed and its weight may vary. A heavier paper can absorb more resin, resulting in a thicker melamine layer.

1. Sheet of decorative paper saturated with melamine resin.
2. Chipboard.
3. Sheet of decorative paper saturated with melamine resin.

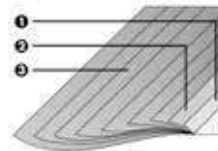

Stratifié
Laminate

Le stratifié à haute pression est constitué d'un empilement de feuilles de papier imprégnées de résines thermodurcissables, qui sont polymérisées sous l'effet d'une pression (8 MPa) et d'une température élevée (150°C).

1. Couche de protection (overlay) imprégnée de résine méla miné (pour tous les décors).
2. Papier décoratif : teinté dans la masse pour les teintes unies ou imprimé pour les décors, imprégné de résine de méla miné.
3. Coeur: un certain nombre de feuilles de papier kraft, imprégnées de résine de phénol.

High-pressure laminate consists of a stack of sheets of paper saturated with thermosetting resin which are polymerized under high pressure (8 MPa) and temperature (150°C).

1. Melamine resin-saturated overlay (for all decors).
2. Decorative paper: mass-dyed for solid colors or printed for decors, saturated with melamine resin.
3. Core: a number of sheets of kraft paper, saturated with phenol resin.

Correspondance Pieds/Plateaux

Matching table tops and bases

Piètements Extérieurs Outdoor Table Bases		Modena 3	Modena 4	Modena Double	Modena 4 Bar	Kyoto 4	Kyoto 4 Bar	Monza	Monza Bar	Berlin 4	Berlin 2	Berlin 4 Bar
Compact Easy 12mm	65x65	-	✓☁	-	✓☁	✓☁	✓☁	✓☁	-	✓☁	-	✓☁
Stratifié Moulé Classic 32mm Basalt Haussmann Granit Light	60x60	-	✓☁	-	✓☁	✓☁	✓☁	✓☁	✓☁	✓☁	-	✓☁
	70x70	-	✓☁	-	✓☁	✓☁	✓☁	✓☁	-	✓☁	-	✓☁
	Ø60	✓☁	-	-	-	-	-	-	✓☁	-	-	-
Stratifié Moulé Cerclés Rimmed Molded Laminate 30mm Marrakesh Mermer Black Siyah	Ø60	✓☁	-	-	-	-	-	-	✓☁	-	-	-
Stratifié Perfect Sense Collection Perfect Sense Laminate 20mm Noir - Black	60x60	-	✓	-	✓	✓	✓	✓	✓	✓	-	✓
	70x70	-	✓	-	✓	✓	✓	✓	-	✓	-	✓
	120x70	-	-	✓	-	-	-	-	-	-	✓	-
Stratifié Original Collection Original Collection Laminate 24mm Noyer - Walnut Marbre Samas - Samas Marble Marmara Marbre Blanc - White Marble	60x60	-	✓	-	✓	✓	✓	✓	✓	✓	-	✓
	70x70	-	✓	-	✓	✓	✓	✓	-	✓	-	✓
	80x80	-	-	-	-	✓	-	-	-	✓	-	-
	60x70	-	✓	-	✓	✓	✓	✓	-	✓	-	✓
	110x70	-	-	✓	-	-	-	-	-	-	✓	-
	120x70	-	-	✓	-	-	-	-	-	-	✓	-
Stratifié Chêne Halifax Oak Halifax Laminate 24mm & 46mm Chêne Halifax Naturel Chêne Halifax Tabac	120x80	-	-	✓	-	-	-	-	-	-	✓	-
	Ø70	-	✓	-	✓	✓	✓	✓	✓	✓	-	✓
	Ø120	-	-	-	-	-	-	-	-	-	-	-
Mélaminé Melamine 18mm Minnesota Oak Chocolat Chêne Halifax Naturel	60x60	-	✓	-	✓	✓	✓	✓	✓	✓	-	✓
	70x70	-	✓	-	✓	✓	✓	✓	-	✓	-	✓
	120x70	-	-	✓	-	-	-	-	-	-	✓	-
Chêne Odense Oak Odense 30mm	60x60	-	✓	-	✓	✓	✓	✓	✓	✓	-	✓
	70x70	-	✓	-	✓	✓	✓	✓	-	✓	-	✓
	120x70	-	-	✓	-	-	-	-	-	-	✓	-

Correspondance Pieds/Plateaux

Matching table tops and bases

Piètements Extérieurs Outdoor Table Bases		Empire 3	Empire 4	Empire 4 Bar	Empire 2	Empire Grande	Bistrot 3 H43	Bistrot 3	Bistrot 4	Bistrot 3 Bar
Compact Easy 12mm	65x65	-	✓☁	-	-	-	-	-	✓☁	-
Stratifié Moulé Classic 32mm Basalt Haussmann Granit Light	60x60	✓☁	✓☁	✓☁	-	-	✓☁	✓☁	✓☁	✓☁
	70x70	-	✓☁	-	-	-	-	-	✓☁	-
	Ø60	✓☁	✓☁	✓☁	-	-	✓☁	✓☁	✓☁	✓☁
Stratifié Moulé Cerclés Rimmed Molded Laminate 30mm Marrakesh Mermer Black Siyah	Ø60	✓☁	✓☁	✓☁	-	-	✓☁	✓☁	✓☁	✓☁
Stratifié Perfect Sense Collection Perfect Sense Laminate 20mm Noir - Black	60x60	✓	✓	✓	-	-	✓	✓	✓	✓
	70x70	-	✓	-	-	-	-	-	✓	-
	120x70	-	-	-	✓	-	-	-	-	-
Stratifié Original Collection Original Collection Laminate 24mm Noyer - Walnut Marbre Samas - Samas Marble Marmara Marbre Blanc - White Marble	60x60	✓	✓	✓	-	-	✓	✓	✓	✓
	70x70	-	✓	-	-	-	-	-	✓	-
	80x80	-	-	-	-	✓	-	-	-	-
	60x70	-	✓	-	-	-	-	-	✓	-
	110x70	-	-	-	✓	-	-	-	-	-
Stratifié Chêne Halifax Oak Halifax Laminate 24mm & 46mm Chêne Halifax Naturel Chêne Halifax Tabac	120x70	-	-	-	✓	-	-	-	-	-
	120x80	-	-	-	✓	-	-	-	-	-
	Ø70	✓	✓	✓	-	-	-	-	✓	✓
Mélaminé Melamine 18mm Minnesota Oak Chocolat Chêne Halifax Naturel	Ø120	-	-	-	-	✓	-	-	-	-
	60x60	✓	✓	✓	-	-	✓	✓	✓	✓
	70x70	-	✓	-	-	-	-	-	✓	-
Chêne Odense Oak Odense 30mm	120x70	-	-	-	✓	-	-	-	-	-
	60x60	✓	✓	✓	-	-	✓	✓	✓	✓
	70x70	-	✓	-	-	-	-	-	✓	-

Correspondance Pieds/Plateaux

Matching table tops and bases

Piètements Intérieurs Indoor Tables Bases		Gallia 4	Gallia 4 Bar	Gallia 4 XL	Gallia Double	Factory 70	Retro Small	Retro Large	Prato 16	Prato 19	Prato 30	Prato 16 Bar	Prato 30 Bar	
Compact Easy 12mm	65x65	✓	✓	-	-	-	-	-	✓	-	-	✓	-	
Stratifié Moulé Classic 32mm Basalt Hausmann Granit Light Avalon Pine Irony Malaga	60x60	✓	✓	-	-	-	-	-	✓	-	-	✓	-	
	70x70	✓	✓	-	-	-	-	-	✓	-	-	✓	-	
	Ø60	✓	✓	-	-	-	-	-	✓	-	-	✓	-	
Stratifié Moulé Cerclés Rimmed Molded Laminate	30mm Marrakesh Mermer Black Siyah	Ø60	✓	✓	-	-	-	-	✓	-	-	✓	-	
Stratifié Perfect Sense Collection Perfect Sense Laminate	60x60	✓	✓	-	-	-	-	-	✓	-	-	✓	-	
	70x70	✓	✓	-	-	✓	-	-	✓	-	-	✓	-	
	20mm Noir - Black	120x70	-	-	-	✓	-	-	-	-	✓	-	✓	
Stratifié Original Collection Original Collection Laminate	60x60	✓	✓	-	-	-	-	-	✓	-	-	✓	-	
	70x70	✓	✓	-	-	✓	-	-	✓	-	-	✓	-	
	24mm Noyer - Walnut Marbre Samas - Samas Marble Marmara Marbre Blanc - White Marble	80x80	-	-	✓	-	-	-	-	-	-	-	-	
	60x70	✓	✓	-	-	-	✓	-	✓	✓	-	✓	-	
	110x70	-	-	-	✓	-	-	✓	-	✓	✓	-	✓	
	120x70	-	-	-	✓	-	-	-	-	-	✓	-	✓	
	Stratifié Chêne Halifax Oak Halifax Laminate	120x80	-	-	-	✓	-	-	-	-	-	✓	-	✓
	24mm & 46mm Chêne Halifax Naturel Chêne Halifax Tabac	Ø70	✓	✓	-	-	-	-	-	✓	-	-	✓	-
Ø120	-	-	✓	-	-	-	-	-	-	-	-	-	-	
Mélaminé Melamine	60x60	✓	✓	-	-	-	-	-	✓	-	-	✓	-	
	18mm	70x70	✓	✓	-	-	✓	-	✓	-	-	✓	-	
	Minnesota Oak Chocolat Chêne Halifax Naturel	120x70	-	-	-	✓	-	-	-	-	✓	-	✓	
Chêne Odense Oak Odense	60x60	✓	✓	-	-	-	-	-	✓	-	-	✓	-	
	70x70	✓	✓	-	-	-	-	-	✓	-	-	✓	-	
	30mm	120x70	-	-	-	✓	-	-	-	-	✓	-	✓	

Correspondance Pieds/Plateaux

Matching table tops and bases

Piètements Intérieurs Indoor Table Bases		Prato 15	Prato 20	Prato 15 Bar	Prato 70	Rome 05	Rome 06	Rome 05 Bar	Rome 12	Rome 13	Rome 12 Bar	
Compact Easy 12mm	65x65	-	✓	-	-	-	✓	-	✓	-	✓	
Stratifié Moulé Classic 32mm	60x60	✓	✓	✓	-	✓	-	✓	✓	-	✓	
	70x70	-	✓	-	-	-	✓	-	✓	-	✓	
	Basalt Haussmann Granit Light	✓	✓	✓	-	✓	-	✓	✓	-	✓	
Avalon Pine Irony Malaga	✓	✓	✓	-	✓	-	✓	✓	-	✓		
Stratifié Moulé Cerclés Rimmed Molded Laminate	30mm	✓	✓	✓	-	✓	-	✓	✓	-	✓	
Marrakesh Mermer Black Siyah	Ø60	✓	✓	✓	-	✓	-	✓	✓	-	✓	
Stratifié Perfect Sense Collection Perfect Sense Laminate	60x60	✓	✓	✓	-	✓	-	✓	✓	-	✓	
	70x70	-	✓	-	-	-	✓	-	✓	-	✓	
	20mm	-	-	-	-	-	-	-	-	✓	-	
Noir - Black	120x70	-	-	-	-	-	-	-	✓	-	-	
Stratifié Original Collection Original Collection Laminate	60x60	✓	✓	✓	-	✓	-	✓	✓	-	✓	
	70x70	-	✓	-	-	-	✓	-	✓	-	✓	
	24mm	-	✓	-	✓	-	✓	-	✓	-	-	
	Noyer - Walnut Marbre Samas - Samas Marble Marmara Marbre Blanc - White Marble	60x70	-	✓	-	-	-	✓	-	✓	✓	✓
	110x70	-	-	-	-	-	-	-	-	✓	-	
Stratifié Chêne Halifax Oak Halifax Laminate	120x70	-	-	-	-	-	-	-	-	✓	-	
	120x80	-	-	-	-	-	-	-	-	✓	-	
	24mm & 46mm	✓	✓	✓	✓	✓	✓	✓	✓	✓	✓	
	Chêne Halifax Naturel Chêne Halifax Tabac	Ø70	✓	✓	✓	✓	✓	✓	✓	✓	✓	
Ø120	-	-	-	✓	-	✓	-	-	-	-		
Mélaminé Melamine	60x60	✓	✓	✓	-	✓	-	✓	✓	-	✓	
	18mm	-	✓	-	-	-	✓	-	✓	-	✓	
	Minnesota Oak Chocolat Chêne Halifax Naturel	120x70	-	-	-	-	-	-	-	✓	-	
Chêne Odense Oak Odense	60x60	✓	✓	✓	-	✓	-	✓	✓	-	✓	
	70x70	-	✓	-	-	-	✓	-	✓	-	✓	
	30mm	-	-	-	-	-	-	-	-	✓	-	
120x70	-	-	-	-	-	-	-	-	✓	-		

Pièces détachées

Spare parts

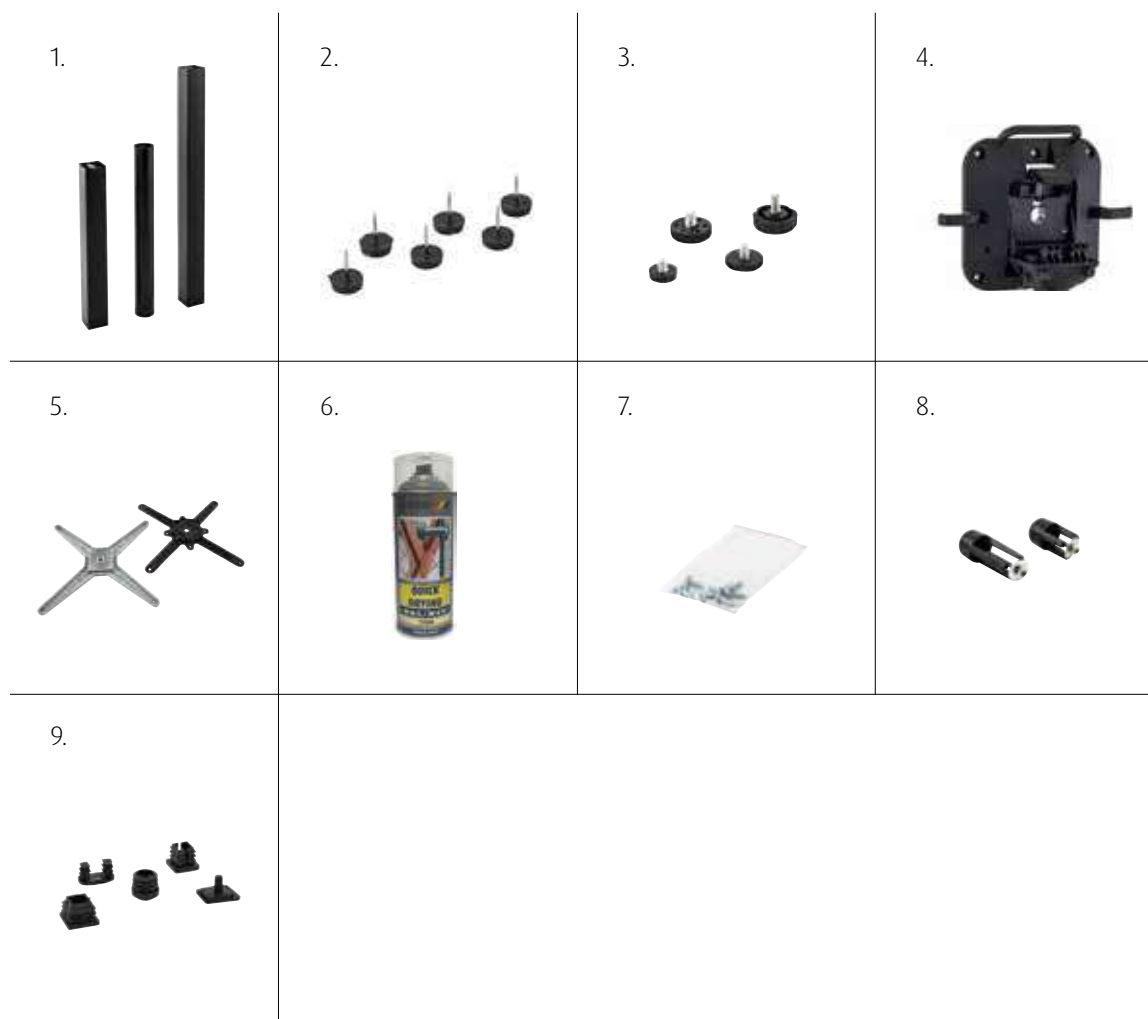

1. Tubes métalliques pour piètements intérieurs. *Metal tubes for indoor table bases.* 2. Patins en nylon à clouer pour mobilier en bois. *Nylon gliders for wooden furniture.* 3. Vérins de réglage pour piètements. *Table bases plugs.* 4. Modena Système basculant. *Modena fliptop system.* 5. Croix de fixation pour piètements. *Cross for table bases.* 6. Bombe aérosol de couleur pour la gamme Bastille & Pigalle - 400ml. *Colour spray can for the Bastille & Pigalle range - 400ml.* 7. Vis de montage pour plateaux de table. *Screws for tables tops.* 8. Empire éléments de fixation. *Assembly parts for the Empire table.* 9. Bouchons PVC pour mobilier intérieur et extérieur. *PVC plugs for outdoor and indoor furniture.*

























Vidéos de montage

























Assembly videos



Retrouvez nos vidéos de montage via ce QR code.
Find our assembly videos via this QR code.





























 <p>New</p> <p>Loom p10</p>	 <p>New</p> <p>Loyd p12</p>	 <p>New</p> <p>Metz p14</p>	 <p>New</p> <p>Dax p16</p>	 <p>Orléans p18</p>
 <p>Rochelle p20</p>	 <p>Brest p22</p>	 <p>Laval p24</p>	 <p>Murcia p26</p>	 <p>Cadix p28</p>
 <p>New</p> <p>Denia p30</p>	 <p>New</p> <p>Alicante p32</p>	 <p>New</p> <p>Javea p34</p>	 <p>Amsterdam p36</p>	 <p>Breda p38</p>
 <p>Stock Limité Limited Stock</p> <p>Savana p40</p>	 <p>New</p> <p>Saint-Raphaël p42</p>	 <p>Stock Limité Limited Stock</p> <p>Concorde p44</p>	 <p>New</p> <p>Odéon p46</p>	 <p>New</p> <p>Bercy p48</p>
 <p>New</p> <p>Limoges p50</p>	 <p>Reims p52</p>	 <p>Blois p54</p>	 <p>Dole p56</p>	 <p>New</p> <p>Paris p58</p>

 <p>Montmartre p60</p>	 <p>Stock limité Limited Stock</p> <p>Drouot p62</p>	 <p>Trocadero p64</p>	 <p>Stock limité Limited Stock</p> <p>Villette p66</p>	 <p>Stock limité Limited Stock</p> <p>Madeleine p68</p>
 <p>Stock limité Limited Stock</p> <p>Dauphine p70</p>	 <p>New</p> <p>Bastille p72</p>	 <p>New</p> <p>Bastille Bst p74</p>	 <p>New</p> <p>Pigalle p76</p>	
 <p>New</p> <p>Doha p78</p>	 <p>New</p> <p>Cairo p80</p>	 <p>Dubai p82</p>	 <p>Jeddah p84</p>	 <p>Oman p86</p>
 <p>Penelope p88</p>	 <p>Ulysse p90</p>	 <p>New</p> <p>Achille Bar 75 p92</p>	 <p>Tom Bar 75 p94</p>	 <p>Monna p96</p>
 <p>Sky Pro p98</p>	 <p>Maya p100</p>	 <p>Maya Bar 75 p102</p>	 <p>Atlantic p104</p>	 <p>Marcel p106</p>

				
Marcel XL p108	Marcel Bar 75 p110	Daytona p112	Panama p114	Jamaica p116
				 New
Jamaica F p118	Jamaica Bst p120	Kys p122	Kys Bar p124	Modena 3 p126
 New	 New	 New	 New	 New
Modena Double p126	Modena 4 p127	Modena 4 Bar p127	Kyoto 4 p128	Kyoto Bar p128
				
Monza p130	Monza Bar p130	Berlin 2 p132	Berlin 4 p132	Berlin 4 Bar p133
				
Empire 3 p134	Empire 4 p134	Empire 4 Bar p134	Empire 2 p135	Empire Grande p135

 <p>Bistrot 3 H43 p136</p>	 <p>Bistrot 3 p136</p>	 <p>Bistrot 4 p137</p>	 <p>Bistrot 3 Bar p137</p>	 <p>Orsay p128</p>
<p>New</p>  <p>Compact Easy 12 mm p140</p>	<p>New</p>  <p>Stratifié Moulé Classic p142</p>	 <p>Stratifié Moulé Cerclé p144</p>		

 <p>New</p> <p>Eloise p148</p>	 <p>New</p> <p>Romeo p150</p>	 <p>New</p> <p>Tristan Bst p152</p>	 <p>New</p> <p>Clothilde p154</p>	 <p>New</p> <p>Ginette p156</p>
 <p>New</p> <p>Angèle p158</p>	 <p>New</p> <p>Marius Bst p160</p>	 <p>New</p> <p>Eugénie p162</p>	 <p>Simone p164</p>	 <p>René p166</p>
 <p>Auguste p168</p>	 <p>Mélina p170</p>	 <p>Sandra p172</p>	 <p>Noélia p174</p>	 <p>Zoé p176</p>
 <p>Ralph p178</p>	 <p>Mikka p180</p>	 <p>Olaf p182</p>	 <p>Jacob p184</p>	 <p>Kyle p186</p>
 <p>Wendy p188</p>	 <p>Maurice p190</p>	 <p>Maurice Bst p192</p>	 <p>College p194</p>	 <p>New</p> <p>Harvard p196</p>

				
Montréal p198	Stanley p200	Stanley Bst p202	Brixton p204	Soho p206
 <small>Stock Limité Limited Stock</small>				
Condor p208	Cuba p210	Cuba Double p212	Kate p214	Budapest p216
				
Budapest Bst p218	Dimitri p220	Dimitri Bst p222	Brooklyn p224	Brooklyn Bst p226
		 <small>New</small>	 <small>New</small>	
Pub p228	Pub Bst p230	Palma p232	Palma Bst p234	Sofia p236
				 <small>Stock Limité Limited Stock</small>
Sofia Bst p238	Emile p240	Alfonse p242	Oscar Bst p244	Lautrec S p246

				
Arnold p248	Willy p250	Floriane II p252	Floriane Bst II p254	Clinton p256
				 New
Clinton Bst p258	Maryne p260	Jolyne p262	Ellen p264	Gallia 4 p266
 New	 New	 New	 Stock Limited Limited Stock	
Gallia 4 Bar p266	Gallia 4 XL p267	Gallia Double p267	Factory p268	Retro Small p269
				
Retro Large p269	Bistro 3 H43 p270	Bistro 3 p270	Bistro 4 p271	Bistro 3 Bar p271
				
Prato 16 p272	Prato 19 p272	Prato 30 p272	Prato 16 Bar p273	Prato 30 Bar p273

 <p>Prato 15 p274</p>	 <p>Prato 15 Bar p274</p>	 <p>Prato 20 p275</p>	 <p>Prato 70 p275</p>	 <p>Rome 05 p276</p>
 <p>Rome 06 p276</p>	 <p>Rome 05 Bar p276</p>	 <p>Rome 12 p277</p>	 <p>Rome 13 p277</p>	 <p>Rome 12 Bar p277</p>
<p>New</p>  <p>Stratifié Original Collection p278</p>	 <p>Stratifié Perfect Sense Collection p280</p>	 <p>Stratifié Chêne Halifax p282</p>	 <p>Mélaminé p284</p>	 <p>Odense p286</p>
 <p>William p288</p>	 <p>Jacky p290</p>			









































Liste de prix - *Price List*











VIF
FURNITURE







www.vif-furniture.com
03.20.20.78.80

Distributeur CHR
indépendant



			Code Article	Poids (kg)	Par multiple de	Q/PALETTE	Prix
P.10		LOOM NEW					
		ROTIN NATUREL	FE1_000090	5,3 kg	1 pc	28 120X100cm	92 €
P.12		LOYD NEW					
		ROTIN NATUREL	FE3_000043	5,9 kg	1 pc	18 120X100cm	102 €
P.14		METZ NEW					
		ROTIN NOISETTE	FE2_000106	3,8 kg	1 pc	14 120X100cm	149 €
P.16		DAX					
		BAMBOO LOOK CARAMEL - ROTIN NOISETTE	FE1_000080	3,5 kg	1 pc	14 120X100cm	129 €
		BAMBOO LOOK FONCÉ - ROTIN BRUN FONCÉ NEW	FE1_000086	3,5 kg	1 pc		129 €
P.18		ORLEANS					
		ROTIN NOISETTE	FE1_000077	3,5 kg	1 pc	18 120X100cm	129 €
P.20		ROCHELLE					
		ROTIN NOISETTE	FE2_000098	4 kg	1 pc	14 120X100cm	139 €
P.22		BREST					
		ROTIN NOISETTE	FE3_000035	2 kg	1 pc	18 120X80cm	95 €
P.24		LAVAL					
		ROTIN NOISETTE	FE3_000037	2,7 kg	1 pc	15 120X100cm	125 €
P.26		MURCIA					
		NOIR	FE2_000101	4,7 kg	1 pc	40 120X100cm	119 €
		TAUPE	FE2_000102	4,7 kg	1 pc		119 €
		TERRACOTTA	FE2_000103	4,7 kg	1 pc		119 €
P.28		Ensemble CADIX - ANTHRACITE					
		1 FAUTEUIL 2 PLACES + 2 FAUTEUILS 1 PLACE + 1 TABLE BASSE	FE7_000006	37,5 kg	1 set	1 120X80cm	1.599 €
P.30		DENIA NEW					
		TERRA	FE2_000108	3,1 kg	1 pc	30 120X100cm	119 €
		SABLE	FE2_000109	3,1 kg	1 pc		119 €
P.32		ALICANTE NEW					
		TERRA	FE3_000041	3,3 kg	1 pc	40 120X100cm	159 €
		SABLE	FE3_000042	3,3 kg	1 pc		159 €
P.34		JAVEA NEW					
		PAILLE	FE2_000107	3,9 kg	1 pc	44 120X100cm	69 €
P.36		AMSTERDAM					
		PAILLE	FE2_000091	3,1 kg	1 pc	30 120X100cm	119 €
		OLIVE	FE2_000092	3,1 kg	1 pc		119 €
		ANTHRACITE	FE2_000095	3,1 kg	1 pc		119 €
P.38		BREDA					
		PAILLE	FE3_000032	3,2 kg	1 pc	40 120X100cm	159 €
		OLIVE	FE3_000033	3,2 kg	1 pc		159 €
		ANTHRACITE	FE3_000034	3,2 kg	1 pc		159 €
P.40		SAVANA - Stock limité					
		OLIVE	FE2_000097	4,4 kg	1 pc	44 120X100cm	85 €
		PAILLE	FE2_000090	4,4 kg	1 pc		85 €
P.42		ST-RAPHAËL NEW					
		ANTHRACITE	FE2_000105	3,8 kg	1 pc	28 120X100cm	89 €
P.44		CONCORDE - Stock limité					
		ANTHRACITE	FE2_000083	3,5 kg	1 pc	44 120X100cm	99 €
P.46		ODEON NEW					
		TEXTILÈNE CRÈME & VERT	FE1_000088	3,9 kg	1 pc	18 120X100cm	105 €
TEXTILÈNE BLANC & CAMEL	FE1_000089	3,9 kg	1 pc				



			Code Article	Poids (kg)	Par multiple de	Q/PALETTE	Prix
P.48		BERCY NEW					
		TEXTILÈNE CRÈME & VERT	FE2_000110	3,5 kg	1 pc	30 120X100cm	124 €
		TEXTILÈNE BLANC & CAMEL	FE2_000111	3,5 kg	1 pc		
P.50		LIMOGES NEW					
		TEXTILÈNE GRIS & BLANC	FE1_000087	4 kg	1 pc	16 120X80cm	129 €
P.52		REIMS					
		TEXTILÈNE GRIS & BEIGE	FE1_000081	3 kg	1 pc	18 120X100cm	89 €
P.54		BLOIS					
		TEXTILÈNE GRIS & BEIGE	FE2_000100	4,1 kg	1 pc	18 120X100cm	96 €
P.56		DOLE					
		TEXTILÈNE GRIS & BEIGE	FE3_000038	2,9 kg	1 pc	10 120X100cm	96 €
P.58		PARIS					
		TEXTILÈNE NOIR & BLANC NEW	FE1_000091	3,5 kg	1 pc	18 120X100cm	95 €
		TEXTILÈNE BORDEAUX & CREME	FE1_000075	3,5 kg	1 pc		95 €
		TEXTILÈNE VERT & CREME	FE1_000076	3,5 kg	1 pc		95 €
TEXTILÈNE NOIR	FE1_000014	3,5 kg	1 pc	95 €			
P.60		MONTMARTRE					
		TEXTILÈNE NOIR	FE2_000042	3,6 kg	1 pc	18 120X100cm	115 €
P.62		DROUOT - Stock limité					
		TEXTILÈNE NOIR & GRIS CLAIR	FE1_000072	3,5 kg	1 pc	20 120X100cm	99 €
P.64		TROCADERO					
		TEXTILÈNE NOIR & GRIS CLAIR	FE2_000089	3,7 kg	1 pc	18 120X100cm	105 €
P.66		VILLETTE - Stock limité					
		NOIR	FE1_000083	3,6 kg	1 pc	20 120X100cm	112 €
P.68		MADELINE - Stock limité					
		NOIR	FE2_000085	4,3 kg	1 pc	18 120X100cm	139 €
P.70		DAUPHINE - Stock limité					
		TEXTILÈNE NOIR	FE2_000094	2,7 kg	1 pc	16 120X80cm	79 €
P.72		BASTILLE					
		TERRA NEW	FE1_000084	4,5 kg	1 pc	40 120X100cm	68 €
		SAUGE NEW	FE1_000085	4,5 kg	1 pc		68 €
ANTHRACITE	FE1_000043	4,5 kg	1 pc	68 €			
P.74		BASTILLE BST					
		TERRA NEW	FE3_000039	6,7 kg	1 pc	24 120X100cm	99 €
		SAUGE NEW	FE3_000040	6,7 kg	1 pc		99 €
ANTHRACITE	FE3_000022	6,7 kg	1 pc	99 €			
P.76		PIGALLE					
		TERRA NEW	FE8_000024	8 kg	1 pc	20 120X80cm	139 €
		SAUGE NEW	FE8_000025	8 kg	1 pc		139 €
ANTHRACITE	FE8_000019	8 kg	1 pc	139 €			
P.78		DOHA NEW					
		ANTHRACITE	FP2_000056	5,8 kg	1 pc	18 120X100cm	79 €
		TAUPE	FP2_000057	5,8 kg	1 pc		79 €
		SAUGE	FP2_000058	5,8 kg	1 pc		79 €
TERRA	FP2_000059	5,8 kg	1 pc	79 €			
P.80		CAIRO NEW					
		ANTHRACITE	FP8_000015	2,6 kg	1 pc	40 120X100cm	59 €
		TAUPE	FP8_000016	2,6 kg	1 pc		59 €
		SAUGE	FP8_000017	2,6 kg	1 pc		59 €
TERRA	FP8_000018	2,6 kg	1 pc	59 €			















			Code Article	Poids (kg)	Par multiple de	Q/PALETTE	Prix	
P.82		DUBAI						
		ANTHRACITE	FP1_000071	4,2 kg	1 pc	20 120X100cm	59 €	
		TAUPE	FP1_000072	4,2 kg	1 pc		59 €	
		SAUGE	FP1_000073	4,2 kg	1 pc		59 €	
TERRA	FP1_000074	4,2 kg	1 pc	59 €				
P.84		JEDDAH						
		ANTHRACITE	FP2_000051	4,7 kg	1 pc	18 120X100cm	69 €	
		TAUPE	FP2_000052	4,7 kg	1 pc		69 €	
		SAUGE	FP2_000053	4,7 kg	1 pc		69 €	
TERRA	FP2_000054	4,7 kg	1 pc	69 €				
P.86		OMAN						
		ANTHRACITE	FP3_000028	5,3 kg	1 pc	20 120X100cm	85 €	
		TAUPE	FP3_000029	5,3 kg	1 pc		85 €	
		SAUGE	FP3_000030	5,3 kg	1 pc		85 €	
TERRA	FP3_000031	5,3 kg	1 pc	85 €				
P.88		PENELOPE						
		NOIR	FP1_000067	4,2 kg	1 pc	40 120X100cm	75 €	
		MARSALA	FP1_000068	4,2 kg	1 pc		75 €	
P.90		ULYSSE						
		NOIR	FP2_000046	5 kg	1 pc	40 120X100cm	80 €	
		MARSALA	FP2_000047	5 kg	1 pc		80 €	
P.92		ACHILLE BAR 75 NEW						
		NOIR	FP3_000034	5,5 kg	1 pc	16 120X120cm	98 €	
		MARSALA	FP3_000035	5,5 kg	1 pc		98 €	
P.94		TOM BAR 75						
		NOIR	FP3_000023	4 kg	4 pcs	40 120X100cm	89 €	
		MARSALA	FP3_000024	4 kg	4 pcs		89 €	
OLIVE	FP3_000025	4 kg	4 pcs	89 €				
P.96		MONNA						
		OCTANE	FP1_000070	3,4 kg	1 pc	40 120X100cm	69 €	
		MOUTARDE	FP1_000069	3,4 kg	1 pc		69 €	
		NOIR	FP1_000059	3,4 kg	1 pc		69 €	
OLIVE	FP1_000060	3,4 kg	1 pc	69 €				
P.98		SKY PRO						
		NOIR	FP2_000042	4,5 kg	4 pcs	16 120X80cm	96 €	
		OLIVE	FP2_000041	4,5 kg	4 pcs		96 €	
P.100		MAYA						
		OLIVE	FP1_000061	3,3 kg	1 pc	44 120X100cm	59 €	
		GRIS FONCÉ	FP1_000062	3,3 kg	1 pc		59 €	
		NOIR	FP1_000057	3,3 kg	1 pc		59 €	
BLANC	FP1_000058	3,3 kg	1 pc	59 €				
P.102		MAYA BAR 75						
		OLIVE	FP3_000021	5,7 kg	1 pc	16 120X120cm	98 €	
		GRIS FONCÉ	FP3_000020	5,7 kg	1 pc		98 €	
		NOIR	FP3_000015	5,7 kg	1 pc		98 €	
BLANC	FP3_000014	5,7 kg	1 pc	98 €				
P.104		ATLANTIC						
		TEXTILÈNE NOIR	FP2_000037	5,5 kg	1 pc	40 120X100cm	98 €	
P.106		MARCEL						
		NOIR	FP1_000064	3,5 kg	1 pc	24 120X80cm	75 €	
P.108		MARCEL XL						
		NOIR	FP2_000036	3,9 kg	1 pc	22 120x100cm	82 €	
P.110		MARCEL BAR 75						
		NOIR	FP3_000022	4,7 kg	1 pc	12 120X100cm	104 €	





		Code Article	Poids (kg)	Par multiple de	Q/PALETTE	Prix
P.112		DAYTONA				
		GRIS FONCÉ	FP1_000015	3,5 kg	1 pc	36 120X100cm
P.114		PANAMA				
		GRIS FONCÉ	FP2_000023	4,3 kg	1 pc	32 120X100cm
P.116		JAMAICA				
		GRIS FONCÉ	FP1_000018	4 kg	1 pc	36 120X100cm
P.118		JAMAICA F				
		GRIS FONCÉ	FP2_000014	4,8 kg	1 pc	32 120X100cm
P.120		JAMAICA BST				
		GRIS FONCÉ	FP3_000012	6 kg	1 pc	32 120X100cm
P.122		KYS				
		NOIR	FP8_000010	7,3 kg	2 pcs	14 120X100cm
P.124		KYS BAR				
		NOIR	FP8_000011	7,5 kg	2 pcs	14 120X100cm









			Code Article	Poids (kg)	Par multiple de	Q/PALETTE	Prix
P.126		MODENA 3 NEW					
		NOIR	FE4_000094	4,6 kg	1 pc	40 120X100cm	99 €
P.126		MODENA DOUBLE NEW					
		NOIR	FE4_000098	7,1 kg	1 pc	20 120X80cm	219 €
P.127		MODENA 4 NEW					
		NOIR	FE4_000093	3,7 kg	1 pc	50 120X100cm	95 €
		ANTHRACITE	FE4_000095	3,7 kg	1 pc		95 €
P.127		MODENA 4 BAR NEW					
		NOIR	FE4_000096	4,3 kg	1 pc	20 120X80cm	119 €
		ANTHRACITE	FE4_000097	4,3 kg	1 pc		119 €
P.128		KYOTO 4 NEW					
		NOIR	FE4_000099	6,7 kg	1 pc	50 120X100cm	169 €
P.128		KYOTO 4 BAR NEW					
		NOIR	FE4_000100	7,3 kg	1 pc	20 120X80cm	189 €
P.129		CABLE NEW					
		ACIER RECOUVERT DE PVC/6 MÈTRES	FE10_00012	0,3 kg	1 pc		12 €
	ACIER RECOUVERT DE PVC/9 MÈTRES	FE10_00014	0,4 kg	16 €			
P.129		CADENAS NEW					
		37x13x44MM	FE10_00013	0,2 kg	1 pc		12 €
P.130		MONZA					
		ANTHRACITE	FE4_000039	4 kg	1 pc	30 120X80cm	83 €
P.130		MONZA BAR					
		ANTHRACITE	FE4_000040	5,8 kg	1 pc	30 120X80cm	89 €
P.132		BERLIN 2					
		NOIR	FE4_000002	4,5 kg	1 pc	30 120X80cm	109 €
P.132		BERLIN 4					
		NOIR	FE4_000007	6,1 kg	1 pc	30 120X80cm	89 €
P.133		BERLIN 4 BAR					
		NOIR	FE4_000006	6,6 kg	1 pc	30 120X80cm	99 €
P.134		EMPIRE 3					
		NOIR	FE4_000024	4,2 kg	1 pc	40 120X80cm	91 €
P.134		EMPIRE 4					
		NOIR	FE4_000026	5,3 kg	1 pc	40 120X80cm	112 €
P.134		EMPIRE 4 BAR					
		NOIR	FE4_000028	5,7 kg	1 pc	20 120X80cm	141 €
P.135		EMPIRE 2					
		NOIR	FE4_000022	6,9 kg	1 pc	30 120X80cm	129 €
P.135		EMPIRE GRANDE					
		NOIR	FE4_000030	6,8 kg	1 pc	40 120X80cm	139 €
P.136		BISTROT 3 H43					
		NOIR	FI4_000119	8,7 kg	1 pc	30 120X80cm	72 €
P.136		BISTROT 3					
		NOIR	FI4_000120	12 kg	1 pc	30 120X80cm	79 €











		Code Article	Poids (kg)	Par multiple de	Q/PALETTE	Prix
P.137		BISTROT 4				
		NOIR	FI4_000122	16 kg	1 pc	30 120X80cm
P.137		BISTROT 3 BAR				
		NOIR	FI4_000118	22 kg	1 pc	20 120X80cm
P.138		ORSAY NEW				
		NOIR - MARBRE BLANC - CERCLAGE DORÉ	FE8_000026	16,6 kg	1 pc	20 120X80cm











		Code Article	Poids (kg)	Par multiple de	Q/PALETTE	Prix			
P.140		COMPACT EASY 65x65cm							
		ALASKA OAK 694 NEW	FES_000203	5,8 kg	1 pc	50 120X80cm	86 €		
		BLACK METEOR 11 NEW	FES_000202	5,8 kg	1 pc		86 €		
		PADOVA 804 NEW	FES_000204	5,8 kg	1 pc		86 €		
		TERRAZZO 669 NEW	FES_000201	5,8 kg	1 pc		86 €		
		MARMO GRIGGIO 671	FES_000199	5,8 kg	1 pc		86 €		
		GRAFITO 918	FES_000200	5,8 kg	1 pc		86 €		
		SLATE 658	FES_000195	5,8 kg	1 pc		86 €		
		CORTEN 406	FES_000196	5,8 kg	1 pc		86 €		
		MARMO BIANCO 654	FES_000197	5,8 kg	1 pc		86 €		
		COLORADO 459	FES_000198	5,8 kg	1 pc		86 €		
		Visserie incluse							
		P.142		STRATIFIÉ MOULÉ CLASSIC					
BASALT 5810 - 60x60cm NEW	FES_000211			5,9 kg	1 pc	50 120X80cm	61 €		
BASALT 5810 - 70x70cm NEW	FES_000212			8 kg	1 pc		65 €		
BASALT 5810 - R60cm NEW	FES_000213			5,3 kg	1 pc		52 €		
HAUSSMANN 4723 - 60x60cm NEW	FES_000208			5,9 kg	1 pc		61 €		
HAUSSMANN 4723 - 70x70cm NEW	FES_000209			8 kg	1 pc		65 €		
HAUSSMANN 4723 - R60cm NEW	FES_000210			5,3 kg	1 pc		52 €		
GRANIT LIGHT 5807 - 60x60cm NEW	FES_000205			5,9 kg	1 pc		61 €		
GRANIT LIGHT 5807 - 70x70cm NEW	FES_000206			8 kg	1 pc		65 €		
GRANIT LIGHT 5807 - R60cm NEW	FES_000207			5,3 kg	1 pc		52 €		
AVALON PINE 4729 - 60x60cm	FES_000186			5,9 kg	1 pc		61 €		
AVALON PINE 4729 - 70x70cm	FES_000187			8 kg	1 pc		65 €		
AVALON PINE 4729 - R60cm	FES_000188			5,3 kg	1 pc		52 €		
IRONY 9687 - 60x60cm	FES_000189			5,9 kg	1 pc		61 €		
IRONY 9687 - 70x70cm	FES_000190			8 kg	1 pc		65 €		
IRONY 9687 - R60cm	FES_000191			5,3 kg	1 pc		52 €		
MALAGA 5766 - 60x60cm	FES_000192			5,9 kg	1 pc		61 €		
MALAGA 5766 - 70x70cm	FES_000193			8 kg	1 pc		65 €		
MALAGA 5766 - R60cm	FES_000194			5,3 kg	1 pc		52 €		
⚠ Visserie vendue séparément									
P.144		STRATIFIÉ MOULÉ CERCLES R60CM - CERCLAGE LAITON							
		MARRAKESH 5717 - LAITON	FES_000180	4,9 kg	1 pc	50 120X80cm	119 €		
		MERMER 5410 - LAITON	FES_000003	4,9 kg	1 pc		119 €		
		BLACK SIYAH 3190 - LAITON	FES_000179	4,9 kg	1 pc		119 €		
⚠ Visserie vendue séparément									



















		Code Article	Poids (kg)	Par multiple de	Q/PALETTE	Prix		
P.148		ÉLOÏSE NEW						
		WIND VERT 75	FI1_000895	6 kg	2 pcs	24 120X100cm	132 €	
		WIND TERRA 56	FI1_000896	6 kg	2 pcs		132 €	
		WIND GREIGE 05	FI1_000897	6 kg	2 pcs		132 €	
P.150		ROMEO NEW						
		WIND VERT 75	FI2_000485	9 kg	2 pcs	12 120X80cm	202 €	
		WIND TERRA 56	FI2_000486	9 kg	2 pcs		202 €	
		WIND GREIGE 05	FI2_000487	9 kg	2 pcs		202 €	
P.152		TRISTAN BST NEW						
		WIND VERT 75	FI3_000769	9 kg	1 pc	8 120X100cm	259 €	
		WIND TERRA 56	FI3_000770	9 kg	1 pc		259 €	
		WIND GREIGE 05	FI3_000771	9 kg	1 pc		259 €	
P.154		CLOTHILDE NEW						
		WIND VERT 75	FI2_000488	13,3 kg	1 pc	2 120X80cm	259 €	
		WIND TERRA 56	FI2_000489	13,3 kg	1 pc		259 €	
		WIND GREIGE 05	FI2_000490	13,3 kg	1 pc		259 €	
P.156		GINETTE NEW						
		SORELLA GREIGE 05	FI1_000900	6 kg	2 pcs	24 120X100cm	159 €	
		SORELLA GRIS FONCÉ 88	FI1_000901	6 kg	2 pcs		159 €	
P.158		ANGÈLE NEW						
		SORELLA GREIGE 05	FI1_000898	7 kg	2 pcs	24 120X100cm	169 €	
		SORELLA GRIS FONCÉ 88	FI1_000899	7 kg	2 pcs		169 €	
P.160		MARIUS BST NEW						
		SORELLA GREIGE 05	FI3_000772	9 kg	1 pc	8 120X100cm	259 €	
		SORELLA GRIS FONCÉ 88	FI3_000773	9 kg	1 pc		259 €	
P.162		EUGÉNIE NEW						
		SORELLA GREIGE 05	FI2_000491	13,3 kg	1 pc	2 120X80cm	259 €	
		SORELLA GRIS FONCÉ 88	FI2_000492	13,3 kg	1 pc		259 €	
P.164		SIMONE						
		ARAGON TERRA 59	FI1_000880	5,3 kg	2 pcs	12 120X100cm	99 €	
		ARAGON VERT 39	FI1_000881	5,3 kg	2 pcs		99 €	
		ARAGON GRIS CLAIR 83	FI1_000882	5,3 kg	2 pcs		99 €	
P.166		RENÉ						
		ARAGON TERRA 59	FI2_000475	6,5 kg	2 pcs	12 120X80cm	119 €	
		ARAGON VERT 39	FI2_000476	6,5 kg	2 pcs		119 €	
		ARAGON GRIS CLAIR 83	FI2_000477	6,5 kg	2 pcs		119 €	
P.168		AUGUSTE						
		ARAGON TERRA 59	FI3_000759	8,4 kg	2 pcs	12 120X100cm	129 €	
		ARAGON VERT 39	FI3_000760	8,4 kg	2 pcs		129 €	
		ARAGON GRIS CLAIR 83	FI3_000761	8,4 kg	2 pcs		129 €	
P.170		MÉLINA						
		GAVA GRIS 18	FI1_000887	5,4 kg	2 pcs	12 120X80cm	132 €	
P.172		SANDRA						
		GAVA GRIS 18	FI3_000764	6 kg	2 pcs	12 120X100cm	142 €	
P.174		NOÉLIA						
		BREGO GRIS 10 / MÉTAL NOIR	FI1_000888	5,6 kg	2 pcs	12 120X80cm	129 €	
P.176		ZOÉ					ARTICLE COMPOSÉ !	94 €
		STRUCTURE					16 120X100cm	
		MÉTAL NOIR / BOIS NATUREL	FI13_00013	3,7 kg	2 pcs	55 €		
		MÉTAL BLANC / BOIS NATUREL	FI13_00014	3,7 kg	2 pcs	55 €		
		ASSISE						
		MISS BEIGE 032	FI14_00035	2,3 kg	1 pc	39 €		
		MISS GRIS/BRUN 056	FI14_00036	2,3 kg	1 pc	39 €		
		MISS ORANGE 106	FI14_00037	2,3 kg	1 pc	39 €		
MISS OLIVE 144	FI14_00038	2,3 kg	1 pc	39 €				







		Code Article	Poids (kg)	Par multiple de	Q/PALETTE	Prix		
P.178		RALPH				ARTICLE COMPOSÉ !	108 €	
		STRUCTURE						
		MÉTAL NOIR / BOIS NATUREL	FI15_00013	5 kg	2 pcs	8 120X80cm	69 €	
		MÉTAL BLANC / BOIS NATUREL	FI15_00014	5 kg	2 pcs		69 €	
		ASSISE						
		MISS BEIGE 032	FI14_00039	1,8 kg	1 pc		39 €	
		MISS GRIS/BRUN 056	FI14_00040	1,8 kg	1 pc		39 €	
MISS ORANGE 106	FI14_00041	1,8 kg	1 pc	39 €				
		MISS OLIVE 144	FI14_00042	1,8 kg	1 pc	39 €		
P.180		MIKKA						
		COLORADO CUIOIO	FI1_000883	7,4 kg	2 pcs	12	119 €	
		COLORADO ANTHRACITE	FI1_000884	7,4 kg	2 pcs	120X100cm	119 €	
P.182		OLAF						
		COLORADO CUIOIO	FI2_000478	6,8 kg	2 pcs	12	145 €	
		COLORADO ANTHRACITE	FI2_000479	6,8 kg	2 pcs	120X100cm	145 €	
P.184		JACOB						
		COLORADO CUIOIO	FI1_000885	5 kg	2 pcs	12	109 €	
		COLORADO ANTHRACITE	FI1_000886	5 kg	2 pcs	120X80cm	109 €	
P.186		KYLE						
		COLORADO CUIOIO	FI3_000762	6,1 kg	2 pcs	12	129 €	
		COLORADO ANTHRACITE	FI3_000763	6,1 kg	2 pcs	120X100cm	129 €	
P.188		WENDY						
		COLORADO CUIOIO	FI0_000087	30 kg	1 pc	6	329 €	
		COLORADO ANTHRACITE	FI0_000088	30 kg	1 pc	120X100cm	329 €	
P.190		MAURICE						
		ANTHRACITE	FI1_000536	5,8 kg	2 pcs	24	109 €	
		COGNAC	FI1_000535	5,8 kg	2 pcs	120X100cm	109 €	
P.192		MAURICE BST H65						
		ANTHRACITE	FI3_000720	6,3 kg	2 pcs	16	129 €	
		COGNAC	FI3_000719	6,3 kg	2 pcs	120X100cm	129 €	
P.192		MAURICE BST H79						
		ANTHRACITE	FI3_000460	6,8 kg	2 pcs	16	129 €	
		COGNAC	FI3_000459	6,8 kg	2 pcs	120X100cm	129 €	
P.194		COLLEGE						
		TEINTE BRUN VINTAGE	FI1_000889	4,8 kg	1 pc	12 120X80cm	79 €	
P.196		HARVARD NEW						
		TEINTE BRUN VINTAGE	FI3_000768	6,9 kg	1 pc	12 120X80cm	119 €	
P.198		MONTREAL						
		MARRON VINTAGE	FI2_000480	7,5 kg	2 pcs	12 120X80cm	139 €	
P.200		STANLEY						
		MARRON VINTAGE	FI1_000849	5,5 kg	2 pcs	12 120X80cm	119 €	
P.202		STANLEY BST						
		MARRON VINTAGE	FI3_000736	7,2 kg	2 pcs	12 120X80cm	139 €	
P.204		BRIXTON						
		MARRON VINTAGE	FI2_000401	18,5 kg	1 pc	6 120X80cm	335 €	
P.206		SOHO						
		COGNAC VINTAGE	FI1_000664	7,2 kg	2 pcs	18 120X100cm	125 €	
P.208		CONDOR - Stock limité						
		SOFTYL COGNAC	FI2_000473	9 kg	2 pcs	12	79 €	
		SOFTYL ANTHRACITE	FI2_000474	9 kg	2 pcs	120X80cm	79 €	

		Code Article	Poids (kg)	Par multiple de	Q/PALETTE	Prix		
P.210		CUBA						
		CORTES BRUN CLAIR 41	FI2_000390	16,8 kg	1 pc	6 140X100cm	342 €	
P.212		CUBA DOUBLE						
		CORTES BRUN CLAIR 41	FI2_000392	22,3 kg	1 pc	3 120X100cm	432 €	
P.214		KATE					ARTICLE COMPOSÉ !	106 €
		STRUCTURE					12 120X100cm	
		HÊTRE - TEINTE CHÊNE MIEL	FI13_00011	3,3 kg	2 pcs	87 €		
		HÊTRE - NOIR	FI13_00012	3,3 kg	2 pcs	87 €		
		ASSISE						
		LUIS ROUILLE 52	FI14_00030	1,8 kg	1 pc	19 €		
		LUIS VERT 34	FI14_00031	1,8 kg	1 pc	19 €		
		LUIS BLEU 75	FI14_00032	1,8 kg	1 pc	19 €		
LUIS GRIS 90	FI14_00033	1,8 kg	1 pc	19 €				
P.216		BUDAPEST					ARTICLE COMPOSÉ !	156 €
		STRUCTURE					12 120X100cm	
		HÊTRE - TEINTE CHÊNE MIEL	FI13_00008	4,1 kg	2 pcs	137 €		
		HÊTRE - TEINTE WENGÉ	FI13_00009	4,1 kg	2 pcs	137 €		
		ASSISE						
		LOTOS BORDEAUX 5269	FI14_00021	1,8 kg	1 pc	19 €		
		LOTOS TERRA 9244	FI14_00023	1,8 kg	1 pc	19 €		
		LOTOS CAPPUCINO 5582	FI14_00022	1,8 kg	1 pc	19 €		
		LOTOS ÉLÉPHANT 5272	FI14_00019	1,8 kg	1 pc	19 €		
LOTOS OLIVE 9430	FI14_00020	1,8 kg	1 pc	19 €				
LOTOS NOIR 7006	FI14_00018	1,8 kg	1 pc	19 €				
P.218		BUDAPEST BST					ARTICLE COMPOSÉ !	198 €
		STRUCTURE					8 120X100cm	
		HÊTRE - TEINTE CHÊNE MIEL	FI15_00008	5,9 kg	1 pc	179 €		
		HÊTRE - TEINTE WENGÉ	FI15_00009	5,9 kg	1 pc	179 €		
		ASSISE						
		LOTOS BORDEAUX 5269	FI14_00021	1,8 kg	1 pc	19 €		
		LOTOS TERRA 9244	FI14_00023	1,8 kg	1 pc	19 €		
		LOTOS CAPPUCINO 5582	FI14_00022	1,8 kg	1 pc	19 €		
		LOTOS ÉLÉPHANT 5272	FI14_00019	1,8 kg	1 pc	19 €		
LOTOS OLIVE 9430	FI14_00020	1,8 kg	1 pc	19 €				
LOTOS NOIR 7006	FI14_00018	1,8 kg	1 pc	19 €				
P.220		DIMITRI					ARTICLE COMPOSÉ !	147 €
		STRUCTURE					12 120X100cm	
		HÊTRE - TEINTE CHÊNE MIEL	FI13_00007	3,9 kg	2 pcs	126 €		
		ASSISE						
LOTOS NOIR 7006	FI14_00029	1,8 kg	1 pc	21 €				
P.222		DIMITRI BST					ARTICLE COMPOSÉ !	207 €
		STRUCTURE					8 120X100cm	
		HÊTRE - TEINTE CHÊNE MIEL	FI15_00007	5,6 kg	1 pc	186 €		
		ASSISE						
LOTOS NOIR 7006	FI14_00029	1,8 kg	1 pc	21 €				
P.224		BROOKLYN					ARTICLE COMPOSÉ !	136 €
		STRUCTURE					12 120X100cm	
		HÊTRE - TEINTE WENGÉ	FI13_00010	7 kg	2 pcs	117 €		
		ASSISE						
		LOTOS BORDEAUX 5269	FI14_00025	1,6 kg	1 pc	19 €		
		LOTOS NOIR 7006	FI14_00026	1,6 kg	1 pc	19 €		
LOTOS CHOCOLAT 9314	FI14_00027	1,6 kg	1 pc	19 €				
LOTOS CAPPUCINO 5582	FI14_00028	1,6 kg	1 pc	19 €				

		Code Article	Poids (kg)	Par multiple de	Q/PALETTE	Prix		
P.226		BROOKLYN BST				ARTICLE COMPOSÉ !	191 €	
		STRUCTURE						
		HÊTRE - TEINTE WENGÉ	FI15_00010	9,3 kg	1 pc	8 120X100cm	172 €	
		ASSISE						
		LOTOS BORDEAUX 5269	FI14_00025	1,6 kg	1 pc		19 €	
		LOTOS NOIR 7006	FI14_00026	1,6 kg	1 pc		19 €	
		LOTOS CHOCOLAT 9314	FI14_00027	1,6 kg	1 pc		19 €	
LOTOS CAPPUCCINO 5582	FI14_00028	1,6 kg	1 pc	19 €				
P.228		PUB				ARTICLE COMPOSÉ !	136 €	
		STRUCTURE						
		HÊTRE - TEINTE WENGÉ	FI13_00003	5,1 kg	2 pcs	12 120X100cm	117 €	
		ASSISE						
		LOTOS BORDEAUX 5269	FI14_00025	1,6 kg	1 pc		19 €	
		LOTOS NOIR 7006	FI14_00026	1,6 kg	1 pc		19 €	
		LOTOS CHOCOLAT 9314	FI14_00027	1,6 kg	1 pc		19 €	
LOTOS CAPPUCCINO 5582	FI14_00028	1,6 kg	1 pc	19 €				
P.230		PUB BST				ARTICLE COMPOSÉ !	191 €	
		STRUCTURE						
		HÊTRE - TEINTE WENGÉ	FI15_00003	7,5 kg	1 pc	8 120X100cm	172 €	
		ASSISE						
		LOTOS BORDEAUX 5269	FI14_00025	1,6 kg	1 pc		19 €	
		LOTOS NOIR 7006	FI14_00026	1,6 kg	1 pc		19 €	
		LOTOS CHOCOLAT 9314	FI14_00027	1,6 kg	1 pc		19 €	
LOTOS CAPPUCCINO 5582	FI14_00028	1,6 kg	1 pc	19 €				
P.232		PALMA NEW						
		BRUN FONCÉ	FI1_000902	4,4 kg	2 pcs	12 120X80cm	141 €	
P.234		PALMA BST NEW						
		BRUN FONCÉ	FI3_000775	5,5 kg	1 pc	8 120X80cm	181 €	
P.236		SOFIA						
		NOIR	FI1_000546	4 kg	2 pcs	12 120X100cm	141 €	
		BRUN FONCÉ	FI1_000461	4 kg	2 pcs		141 €	
FRENCH PATINA	FI1_000697	4 kg	2 pcs	151 €				
P.238		SOFIA BST						
		NOIR	FI3_000458	5,3 kg	1 pc	8 120X100cm	181 €	
		BRUN FONCÉ	FI3_000363	5,3 kg	1 pc		181 €	
FRENCH PATINA	FI3_000585	5,3 kg	1 pc	192 €				
P.240		EMILE						
		MONOLITH GOLD 48	FI1_000859	6 kg	2 pcs	24 120X100cm	132 €	
		MONOLITH OLIVE 38	FI1_000860	6 kg	2 pcs		132 €	
		MONOLITH PETROL 76	FI1_000861	6 kg	2 pcs		132 €	
MONOLITH ANTHRACITE 92	FI1_000862	6 kg	2 pcs	132 €				
P.242		ALFONSE						
		MONOLITH GOLD 48	FI2_000463	9 kg	2 pcs	12 120X80cm	202 €	
		MONOLITH OLIVE 38	FI2_000464	9 kg	2 pcs		202 €	
		MONOLITH PETROL 76	FI2_000465	9 kg	2 pcs		202 €	
MONOLITH ANTHRACITE 92	FI2_000466	9 kg	2 pcs	202 €				
P.244		OSCAR BST						
		MONOLITH OLIVE 38	FI3_000747	9 kg	1 pc	8 120X100cm	259 €	
		MONOLITH PETROL 76	FI3_000748	9 kg	1 pc		259 €	
		MONOLITH ANTHRACITE 92	FI3_000749	9 kg	1 pc		259 €	
MONOLITH GOLD 48	FI3_000750	9 kg	1 pc	259 €				

		Code Article	Poids (kg)	Par multiple de	Q/PALETTE	Prix	
P.246		LAUTREC S - Stock limité					
		MONOLITH GOLD 48	FI2_000458	10,4 kg	1 pc	3 120X80cm	245 €
		MONOLITH OLIVE 38	FI2_000459	10,4 kg	1 pc		245 €
		MONOLITH PETROL 76	FI2_000460	10,4 kg	1 pc		245 €
MONOLITH ANTHRACITE 92	FI2_000461	10,4 kg	1 pc	245 €			
P.248		ARNOLD					
		MONOLITH ANTHRACITE 92	FI2_000467	27,5 kg	1 pc	4 120X100cm	489 €
		MONOLITH PETROL 76	FI2_000468	27,5 kg	1 pc		489 €
MONOLITH GOLD 48	FI2_000469	27,5 kg	1 pc	489 €			
P.250		WILLY					
		MONOLITH GOLD 48	FI2_000470	39 kg	1 pc	2 120X100cm	629 €
		MONOLITH PETROL 76	FI2_000471	39 kg	1 pc		629 €
MONOLITH ANTHRACITE 92	FI2_000472	39 kg	1 pc	629 €			
P.252		FLORIANE II					
		TAUPE 926	FI1_000879	7,5 kg	2 pcs	12 120X100cm	95 €
		NOIR 9100	FI1_000878	7,5 kg	2 pcs		95 €
CHOCOLAT 928	FI1_000877	7,5 kg	2 pcs	95 €			
P.254		FLORIANE II BST					
		TAUPE 926	FI3_000758	8,5 kg	1 pc	8 120X100cm	159 €
		NOIR 9100	FI3_000757	8,5 kg	1 pc		159 €
CHOCOLAT 928	FI3_000756	8,5 kg	1 pc	159 €			
P.256		CLINTON					
		HÊTRE - WENGÉ / LOTOS NOIR 7006	FI1_000711	5,8 kg	2 pcs	12 120X100cm	92 €
		HÊTRE - WENGÉ / LOTOS PEPPER 5271	FI1_000712	5,8 kg	2 pcs		92 €
HÊTRE - NATUREL / LOTOS ÉLÉPHANT 5272	FI1_000713	5,8 kg	2 pcs	92 €			
P.258		CLINTON BST					
		HÊTRE - WENGÉ / LOTOS NOIR 7006	FI3_000601	7 kg	1 pc	12 120X100cm	139 €
		HÊTRE - WENGÉ / LOTOS PEPPER 5271	FI3_000602	7 kg	1 pc		139 €
HÊTRE - NATUREL / LOTOS ÉLÉPHANT 5272	FI3_000603	7 kg	1 pc	139 €			
P.260		MARYNE set de 2 tables					
		MÉTAL NOIR / MARBRE NOIR	FI8_000006	13,6 kg	1 set	13 120X100cm	129 €
P.262		JOLYNE					
		MÉTAL NOIR / MANGO	FI8_000007	9,5 kg	1 pc	20 120X80cm	109 €
MÉTAL NOIR / NOIR	FI8_000008	9,5 kg					
P.264		ELLEN					
		MÉTAL NOIR / NATUREL	FI8_000005	11,7 kg	1 pc	20 120X80cm	109 €

			Code Article	Poids (kg)	Par multiple de	Q/PALETTE	Prix
P.266		GALLIA 4 NEW					
		NOIR	FI4_000124	8 kg	1 pc	30 120X80cm	89 €
P.266		GALLIA 4 BAR NEW					
		NOIR	FI4_000125	8,9 kg	1 pc	30 120X80cm	105 €
P.267		GALLIA 4 XL NEW					
		NOIR	FI4_000126	11,2 kg	1 pc	30 120X80cm	169 €
P.267		GALLIA DOUBLE NEW					
		NOIR	FI4_000127	12,5 kg	1 pc	30 120X80cm	139 €
P.268		FACTORY 70 - Stock limité					
		GUN MÉTAL	FI4_000098	7 kg	1 pc	24 120X80cm	59 €
P.269		RETRO SMALL					
		NOIR	FI4_000070	16 kg	1 pc	30 120X80cm	88 €
P.269		RETRO LARGE					
		NOIR	FI4_000069	22 kg	1 pc	20 120X80cm	103 €
P.270		BISTROT 3 H43					
		NOIR	FI4_000119	8,7 kg	1 pc	30 120X80cm	72 €
P.270		BISTROT 3					
		NOIR	FI4_000120	12 kg	1 pc	30 120X80cm	79 €
P.271		BISTROT 4					
		NOIR	FI4_000122	16 kg	1 pc	30 120X80cm	86 €
P.271		BISTROT 3 BAR					
		NOIR	FI4_000118	22 kg	1 pc	20 120X80cm	149 €
P.272		PRATO 16					
		NOIR	FI4_000104	12,5 kg	1 pc	30 120X80cm	89 €
P.272		PRATO 19					
		NOIR	FI4_000105	18,5 kg	1 pc	24 120X80cm	126 €
P.272		PRATO 30					
		NOIR	FI4_000106	28,5 kg	1 pc	15 120X80cm	172 €
P.273		PRATO 16 BAR					
		NOIR	FI4_000107	14,2 kg	1 pc	30 120X80cm	105 €
P.273		PRATO 30 BAR					
		NOIR	FI4_000108	31,9 kg	1 pc	15 120X80cm	186 €
P.274		PRATO 15					
		NOIR	FI4_000109	10,9 kg	1 pc	30 120X80cm	88 €
P.274		PRATO 15 BAR					
		NOIR	FI4_000112	12,1 kg	1 pc	30 120X80cm	104 €
P.275		PRATO 20					
		NOIR	FI4_000110	17,4 kg	1 pc	24 120X80cm	138 €

			Code Article	Poids (kg)	Par multiple de	Q/PALETTE	Prix
P.275		PRATO 70					
		NOIR	FI4_000111	30,9 kg	1 pc	15 120X80cm	198 €
P.276		ROME 05					
		NOIR	FI4_000072	14 kg	1 pc	30 120X80cm	99 €
P.276		ROME 06					
		NOIR	FI4_000073	21 kg	1 pc	24 120X80cm	129 €
P.276		ROME 05 BAR					
		NOIR	FI4_000071	15 kg	1 pc	30 120X80cm	109 €
P.277		ROME 12					
		NOIR	FI4_000075	15 kg	1 pc	30 120X80cm	99 €
P.277		ROME 13					
		NOIR	FI4_000076	19 kg	1 pc	24 120X80cm	125 €
P.277		ROME 12 BAR					
		NOIR	FI4_000074	16 kg	1 pc	30 120X80cm	113 €

NEW

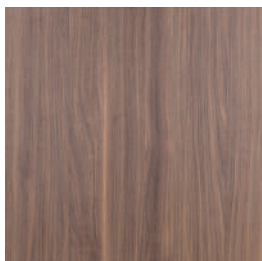

NOYER OH251 W06

NEW

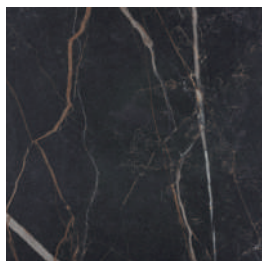

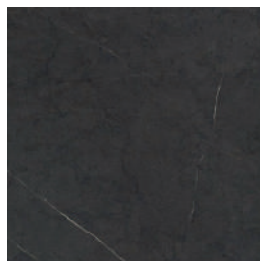

MARBRE SAMAS 3482

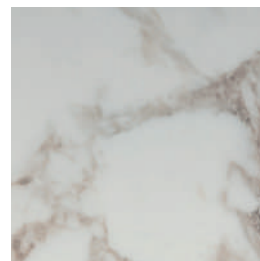

MARMARA F160 ST9



MARBRE BLANC OF253 BST

CHANT 24mm									
	60X60 6,8 kg	70x70 8,1 kg	80X80 10,9 kg	60X70 7,5 kg	110x70 12,9 kg	120X70 14 kg	120X80 16,2 kg	Ø 70 6,4 kg	Ø 120 * 21,3 kg
Prix Public	63 €	89 €	108 €	87 €	138 €	143 €	161 €	114 €	212 €
NOYER OH251 W06 NEW	FI5_000849	FI5_000850	FI5_000851	FI5_000852	FI5_000853	FI5_000854	FI5_000855	FI5_000856	FI5_000857
MARBRE SAMAS 3482 NEW	FI5_000858	FI5_000859	FI5_000860	FI5_000861	FI5_000862	FI5_000863	FI5_000864	FI5_000865	FI5_000866
MARMARA F160 ST9	FI5_000813	FI5_000814	FI5_000815	FI5_000816	FI5_000817	FI5_000818	FI5_000819	FI5_000820	FI5_000821
MARBRE BLANC OF253 BST	FI5_000838	FI5_000839	FI5_000841	FI5_000840	FI5_000842	FI5_000843	FI5_000844	FI5_000845	FI5_000846

* 26 mm



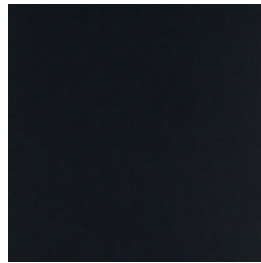

VISSERIE VENDUE SÉPARÉMENT

P.280 **Stratifié**
Perfect Sense Collection





NOIR PT U999

			
CHANT 20mm	60X60 4,8 kg	70X70 6,5 kg	120X70 11,2 kg
Prix Public	72 €	109 €	162 €
NOIR PT U999	F15_000829	F15_000830	F15_000834



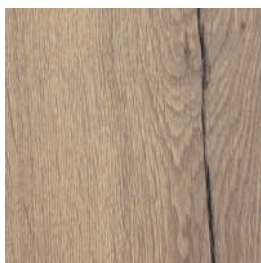
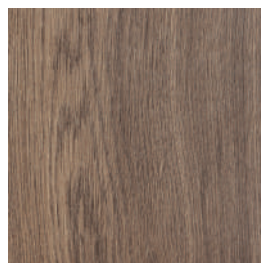

VISSERIE VENDUE SÉPARÉMENT

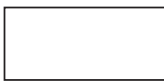
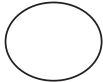
CHÊNE HALIFAX NATUREL
H1180 ST37CHÊNE HALIFAX TABAC
H1181 ST37

CHANT 24mm									
	60X60 5,9 kg	70x70 8,3 kg	80X80 10,4 kg	60X70 7,2 kg	110x70 12,7 kg	120X70 13,7 kg	120X80 16,1 kg	Ø 70 6,5 kg	Ø 120 * 19,7 kg
Prix Public	72 €	109 €	128 €	106 €	155 €	162 €	175 €	118 €	227 €
HALIFAX NATUREL H1180ST37	FIS_000083	FIS_000085	FIS_000086	FIS_000087	FIS_000080	FIS_000081	FIS_000082	FIS_000539	FIS_000542
HALIFAX TABAC H1181ST37	FIS_000091	FIS_000093	FIS_000094	FIS_000515	FIS_000088	FIS_000089	FIS_000090	/	/

*26 mm

CHANT 46mm							
	60X60 8,5 kg	70x70 10,7 kg	80X80 13,5 kg	60X70 9,4 kg	110x70 15,7 kg	120X70 17,1 kg	120X80 19,2 kg
Prix Public	93 €	124 €	169 €	121 €	189 €	189 €	202 €
HALIFAX NATUREL H1180ST37	FIS_000279	FIS_000281	FIS_000282	FIS_000583	FIS_000276	FIS_000277	FIS_000278
HALIFAX TABAC H1181ST37	FIS_000287	FIS_000289	FIS_000290	FIS_000283	FIS_000284	FIS_000285	FIS_000286



VISSERIE VENDUE SÉPARÉMENT



P.284

Mé laminé



MINNESOTA OAK CHOCOLAT
H441 Z5L



CHÊNE HALIFAX NATUREL
H1180 ST37

CHANT 18mm	60X60 4,4 kg		70X70 6,2 kg	120X70 11,2 kg
	Prix Public			
	46 €		53 €	89 €
MINNESOTA OAK CHOCOLAT H441 Z5L	FIS_000715	FIS_000714	FIS_000716	
HALIFAX NATUREL H1180ST37	FIS_000712	FIS_000711	FIS_000713	





VISSERIE VENDUE SÉPARÉMENT

P.286

Odense
Chêne











FINITION NATURELLE
RUSTIQUE BROSSÉE

			
CHANT 30mm	60X60 8,4 kg	70X70 11,1 kg	120X70 19 kg
Prix Public	119 €	149 €	245 €
FINITION NATURELLE RUSTIQUE BROSSÉE	FIS_000823	FIS_000824	FIS_000825



VISSERIE VENDUE SÉPARÉMENT

		Code Article	Poids (kg)	Par multiple de	Q/PALETTE	Prix	
P.288		WILLIAM BUFFET					
		BARDOLINO	FI10_00033	57 kg	1 pc	3	599 €
		WENGÉ	FI10_00036	57 kg	1 pc	120X120cm	599 €
P.290		JACKY					
		BARDOLINO	FI10_00009	32 kg	1 pc	5	559 €
		WENGÉ	FI10_00013	32 kg	1 pc	120X120cm	559 €
P.290		POUBELLE PVC 80 L					
		GRIS	FI10_00015	2,9 kg	1 pc		79 €

		Code Article	Poids (kg)	Par multiple de	Q/PALETTE	Prix	
P.294		TIFFANY - Stock limité					
		NOIR BRILLANT	FP1_000045	4,3 kg	1 pc	14 120X100cm	42 €
P.296		XL 180					
		BLANC	FC8_000005	14,0 kg	1 pc	25 240X80cm	89 €
P.297		COCKTAIL 80					
		BLANC	FC8_000001	8,0 kg	1 pc	30 140X80cm	65 €
P.298		OSAKA					
		NOIR	FC10_00007	0,2 kg	1 pc	-	23 €
P.299		PACK COCKTAIL 80 & OSAKA					
		1 TABLE COCKTAIL 80 + 1 NAPPE OSAKA NOIR	FC17_00001	8,2 kg	1 pc	30 140X80cm	78 €

PIÈCES DÉTACHÉES

Sous réserve d'approvisionnement et de disponibilité - Autres, nous consulter !

Code Article	Descriptif Article	Prix
BOUCHONS POUR MOBILIER EXTERIEUR		
FE9_000160	SACHET DE 20 PATINS PVC 19MM LOOM	12,00 €
FE9_000161	SACHET DE 20 PATINS PVC 16MM LOYD	12,00 €
FE9_000115	SACHET DE 20 PATINS PVC 28MM BREST, LAVAL, LIMOGES, METZ	12,00 €
FE9_000128	SACHET DE 20 PATINS PVC 25MM DAX BRUN CLAIR	12,00 €
FE9_000155	SACHET DE 20 PATINS PVC 25MM DAX BRUN FONCE	12,00 €
FE9_000116	SACHET DE 20 PATINS PVC 28MM ORLEANS, ROCHELLE, LOUVRE	12,00 €
FE9_000135	SACHET DE 20 PATINS 24MM MURCIA	12,00 €
FE9_000129	SACHET DE 20 PATINS PVC 31MM CADIX	12,00 €
FE9_000158	SACHET DE 20 PATINS PVC 32MM DENIA ET ALICANTE	12,00 €
FE9_000156	SACHET DE 20 PATINS PVC 19MM JAVEA	12,00 €
FE9_000101	SACHET DE 20 PATINS PVC 19MM AMSTERDAM	12,00 €
FE9_000102	SACHET DE 20 PATINS PVC 19MM BREDA	12,00 €
FE9_000100	SACHET DE 20 PATINS PVC 22MM SAVANA	12,00 €
FE9_000049	SACHET DE 20 PATINS PVC ST TROPEZ & ST RAPHAEL 10 AVANT+10 ARRIERE	12,00 €
FE9_000130	SACHET DE 20 PATINS PVC 28MM REIMS, DOLE, ODEON	12,00 €
FE9_000154	SACHET DE 20 PATINS PVC 19MM BERCY	12,00 €
FE9_000131	SACHET DE 20 PATINS PVC BLOIS 10 AVANT+10 ARRIERE	12,00 €
FE9_000041	SACHET DE 20 PATINS PVC 28MM PARIS	12,00 €
FE9_000110	SACHET DE 20 PATINS PVC MONTMARTRE, TROCADERO, DROUOT	12,00 €
FE9_000098	SACHET DE 20 PATINS PVC MADELEINE, SORBONNE, PASSY, SEINE, VILLETTE	12,00 €
FE9_000103	SACHET DE 20 PATINS PVC DAUPHINE	12,00 €
FE9_000014	SACHET DE 20 PATINS PVC BASTILLE	12,00 €
FE9_000015	SACHET DE 20 PATINS PVC BASTILLE BST	12,00 €
FE9_000055	SACHET DE 20 PATINS PVC PIGALLE	12,00 €
FP9_000004	SACHET DE 20 PATINS PVC DUBAI, JEDDAH, OMAN, DOHA	12,00 €
FP9_000006	SACHET DE 20 PATINS PVC CAIRO	12,00 €
FE9_000139	SACHET DE 20 PATINS PVC M8x14 PIED DE TABLE MODENA 3, MODENA 4, MODENA DOUBLE	20,00 €
FE9_000040	SACHET DE 20 PATINS PVC PIED DE TABLE MONZA	12,00 €
FE9_000031	SACHET DE 20 PATINS PVC PIED DE TABLE BERLIN	12,00 €
FE9_000034	SACHET DE 20 PATINS PVC PIED DE TABLE VERONA, EMPIRE	12,00 €

PIÈCES DÉTACHÉES

Sous réserve d'approvisionnement et de disponibilité - Autres, nous consulter !

Code Article	Descriptif Article	Prix
BOUCHONS POUR MOBILIER INTÉRIEUR		
FI9_000275	SACHET DE 20 PATINS A CLOUER ALFONSE, ÉMILE, CLINTON, ROMEO, ELOÏSE, GINETTE, ANGÈLE, PAULETTE, CLOTHILDE, EUGÉNIE, MARIUS BST, TRISTAN BST, OSCAR BST	12,00 €
FI9_000302	SACHET DE 20 PATINS PVC SIMONE, RENÉ	12,00 €
FI9_000303	SACHET DE 20 PATINS PVC AUGUSTE	12,00 €
FI9_000310	SACHET DE 20 PATINS PVC MÉLINA, SANDRA	12,00 €
FI9_000313	SACHET DE 20 PATINS PVC NOÉLIA	12,00 €
FI9_000118	SACHET DE 20 PATINS PVC MAURICE, MAURICE BST, ZOE, RALPH	12,00 €
FI9_000307	SACHET DE 20 PATINS PVC MIKKA, OLAF	12,00 €
FI9_000295	SACHET DE 20 PATINS PVC JACOB, KYLE	12,00 €
FI9_000298	SACHET DE 20 PATINS PVC WENDY	12,00 €
FI9_000120	SACHET DE 20 PATINS PVC COLLEGE, HARVARD	12,00 €
FI9_000292	SACHET DE 20 PATINS PVC MONTREAL	12,00 €
FI9_000286	SACHET DE 20 PATINS PVC STANLEY, STANLEY BST	12,00 €
FI9_000183	SACHET DE 20 PATINS PVC BRIXTON	12,00 €
FI9_000315	SACHET DE 20 PATINS PVC SOHO	12,00 €
FI9_000300	SACHET DE 20 PATINS PVC TABLE MARYNE	12,00 €
FI9_000293	SACHET DE 20 PATINS PVC TABLE JOLYNE	12,00 €
FI9_000181	SACHET DE 20 PATINS PVC TABLE ELLEN	12,00 €
FI9_000339	SACHET DE 20 PATINS PVC PIED DE TABLE GALLIA	12,00 €
FI9_000058	SACHET DE 20 PATINS PVC PIED DE TABLE FACTORY	12,00 €
FI9_000064	SACHET 20 PATINS PVC M10x12 PIED TABLE ROME, BISTROT, SYDNEY	12,00 €
FI9_000261	SACHET DE 20 PATINS PVC PIED DE TABLE PRATO	12,00 €
FC9_000009	SACHET DE 20 PATINS PVC TABLE XL180	12,00 €
FC9_000003	SACHET DE 20 PATINS PVC TABLE COCKTAIL 80	12,00 €
VISSERIE - Vis à tôle (T) ou bois (B) à utiliser pour le montage des plateaux stratifiés, Topalit et Werzalit		
FVIS_00001	SACHET DE 8 VIS: 5 x 16 mm (auto-taraudeuse)	2,30 €
FVIS_00002	SACHET DE 8 VIS A TOLE 6,3X25MM	3,00 €
FVIS_00003	SACHET DE 8 VIS A BOIS 5X35MM	2,80 €
FVIS_00004	SACHET DE 8 VIS A BOIS 5X40MM	3,00 €
FVIS_00005	SACHET DE 8 VIS A BOIS 6X30MM	2,80 €
FVIS_00006	SACHET DE 8 VIS A BOIS 6X35MM	2,90 €
FVIS_00007	SACHET DE 8 VIS A BOIS 6X40MM	3,10 €
FVIS_00008	SACHET DE 8 VIS: 5 x 16 mm (auto-taraudeuse)+ rondelle M5 (12x5.5x0.8)	2,30 €
FVIS_00010	SACHET DE 8 VIS A TOLE 4,8X13MM	2,00 €
FVIS_00011	SACHET DE 8 VIS A TOLE 4,8X16MM	2,30 €
FVIS_00012	SACHET DE 8 VIS A TOLE 4,8X19MM	2,80 €
FVIS_00013	SACHET DE 8 VIS A TOLE 4,8X22MM	3,00 €
FVIS_00014	SACHET DE 8 VIS A TOLE 4,8X35MM	3,60 €
FVIS_00015	SACHET DE 8 VIS A TOLE 6,3X22MM	2,60 €
FVIS_00020	SACHET DE 4 VIS: 5 x 20 mm (auto-taraudeuse)	2,30 €
FVIS_00022	SACHET 8 VIS POUR CROIX +COMP. EASY (POUR 2 PLATEAUX)	3,00 €
FVIS_00023	SACHET 4 VIS POUR CROIX +COMP. EASY 1 (POUR 1 PLATEAU)	3,00 €
FVIS_00024	SACHET DE 6 VIS M6X20	2,40 €
FVIS_00025	SACHET 4 VIS POUR CROIX COMP. EASY 2 (POUR 1 PLATEAU)	6,00 €
FVIS_00026	SACHET 4 VIS 35MM-CROIX COMP. EASY 2+BISTROT(1 PLATEAU)	6,00 €
FVIS_00027	SACHET DE 4 VIS A TOLE 4,8X25MM	3,00 €



VIF

FURNITURE

www.vif-furniture.com

03.20.20.78.80

TREMERY (METZ)

Distributeur CHR
indépendant